

innovative infrared technology

BASIC PRINCIPLES

of non-contact
temperature measurement



Contents

	Page
Physical principles	4 – 9
Emissivity and temperature measurement	10 – 14
Optics, sighting techniques and electronics of pyrometers	15 – 18
Sensors and applications of non-contact temperature measurement	19
Infrared cameras and applications	20 – 28
Infrared thermometers and applications	29 – 31
Portable infrared thermometers	32
Appendix: Glossary	33
Appendix: Emissivity table	34 – 37
Appendix: Selection criteria for IR temperature measurement devices	38
Literature.....	39

Physical principles

Physical principles

With our eyes we see the world in visible light. Although visible light makes up only a small part of the radiation spectrum, the invisible light covers most of the remaining spectral range. The radiation of invisible light carries much more additional information.

The infrared temperature measurement system

Each body with a temperature above absolute zero ($-273,15\text{ °C}$ [$-459,67\text{ °F}$] = 0 Kelvin) emits electromagnetic radiation from its surface, which is proportional to its intrinsic temperature. A part of this so-called intrinsic radiation is infrared radiation, which can be used to measure a body's temperature. This radiation penetrates the atmosphere. With the help of a lens (input optics) the beams are focused on a detector element, which generates an electrical signal proportional to the radiation. The signal is amplified and, using successive digital signal processing, is transformed into an output signal proportional to the object temperature. The measu-

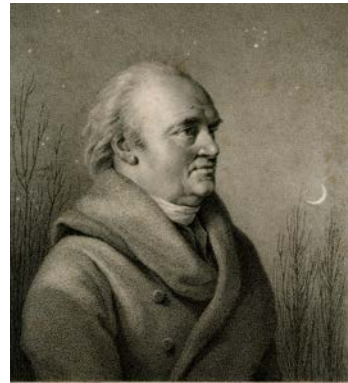

William Herschel (1738–1822)

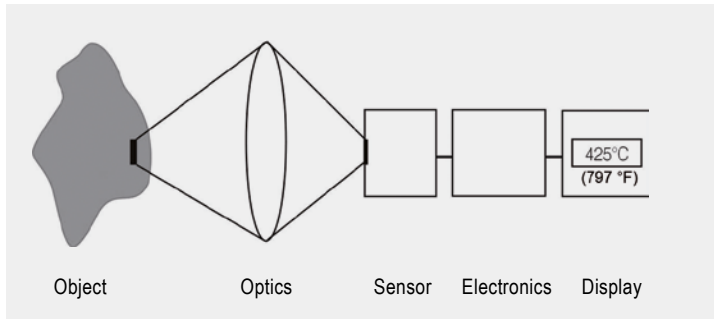

Infrared System

ring value may be shown in a display or released as analog output signal, which supports an easy connection to control systems of the process management.

The advantages of non-contact temperature measurement are obvious – it supports:

- Temperature measurements of moving or overheated objects and of objects in hazardous surroundings
- Very fast response and exposure times
- Non-interactive measurement, no influence on the measuring object
- Non-destructive measurement
- Measurement point durability, no mechanical wear

Discovery of the infrared radiation

Searching for new optical material, William Herschel accidentally discovered the infrared radiation in 1800. He blackened the tip of a sensitive mercury thermometer and used it as measuring system to test the heating properties of different colors of the spectrum, which were directed to a tabletop by having beams of light shine through a glass prism. With this, he tested the heating of different colors of the spectrum. When he moved the thermometer in the dark area beyond the red end of the spectrum, Herschel noticed that the temperature continued to rise. The temperature rose even more in the area behind the red end of the spectrum. He ultimately found the point of maximum temperature far behind the red area. Today this area is called “infrared wavelength area”.

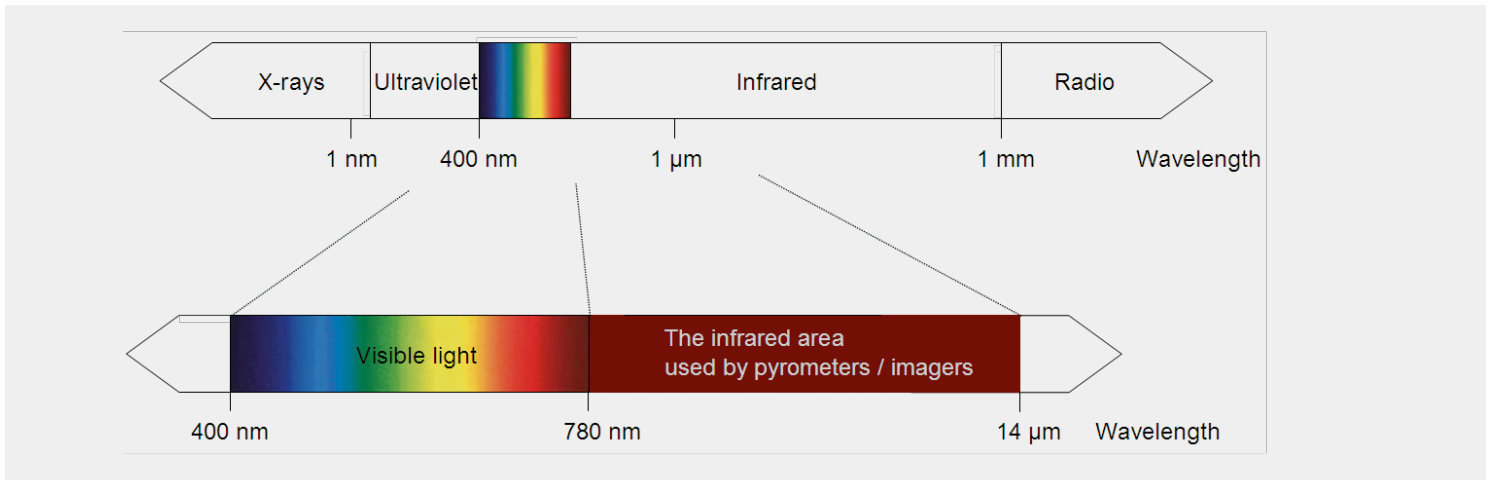

The electromagnetic spectrum with the infrared area used by pyrometers.

The electromagnetic radiation spectrum

In a literal and physical sense, a spectrum is understood as the intensity of a mixture of electromagnetic waves that function as wavelength or frequency. The electromagnetic radiation spectrum covers a wavelength area of about 23 decimal powers and varies from sector to sector in origin, creation and application of the radiation. All types of electromagnetic radiation follow similar principles of diffraction, refraction, reflection and polarization. Their expansion speed corresponds to the light speed under normal conditions: The result of multiplying wavelength with frequency is constant:

$$\lambda \cdot f = c$$

The infrared radiation covers a very limited part in the whole range of the electromagnetic spectrum: It starts at the visible range of about 0.78 μm and ends at wavelengths of approximately 1000 μm.

Wavelengths ranging from 0.7 to 14 μm are important for infrared temperature measurement. Above these wavelengths the energy level is so low, that detectors are not sensitive enough to detect them.

Physical principles

In 1900 Max Planck, Josef Stefan, Ludwig Boltzmann, Wilhelm Wien and Gustav Kirchhoff precisely defined the electromagnetic spectrum and established qualitative and quantitative correlations for describing infrared energy.

The black body

A black body is an abstracted physical body, which absorbs all incoming radiation. It has neither reflective nor transmissive properties.

$$\alpha = \varepsilon = 1 \quad (\alpha \text{ absorption, } \varepsilon \text{ emissivity})$$

A black body radiates the maximum energy possible at each wavelength. The concentration of the radiation does not depend on angles. The black body is the basis for understanding the physical principles of non-contact temperature measurement and for calibrating infrared thermometers.

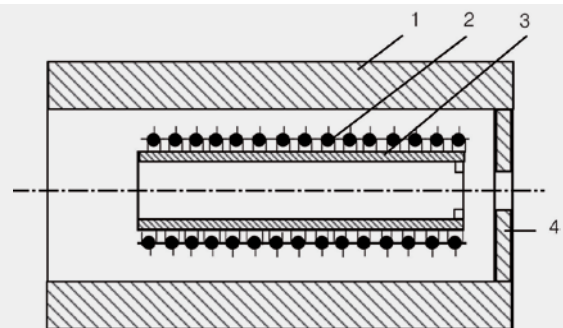

Cross section of a black body:

1 – ceramic conduit, 2 – heating, 3 – conduit made from Al₂O₃, 4 – aperture

The construction of a black body is simple. A thermal hollow body has a small hole at one end. If the body is heated and reaches a certain temperature, and if temperature equilibrium is reached inside the hollow room, the hole ideally emits black radiation of the set temperature. For each temperature range and application purpose the construction of these black bodies depends on material and the geometric structure. If the hole is very small compared to the surface as a whole, the interference of the ideal state is very small.

Physical principles

If you point the measuring device on this hole, you can declare the temperature emitting from inside as black radiation which you can use for calibrating your measuring device. In reality, simple systems use surfaces, which are covered with pigmented paint and show absorption and emissivity values of 99 % within the required wavelength range. Usually, this is sufficient for calibrations of actual measurements.

Radiation principles of a black body

The radiation law by Planck shows the basic correlation for non-contact temperature measurements: It describes the spectral specific radiation M_{λ_s} of the black body into the half space depending on its temperature T and the wavelength λ .

$$M_{\lambda_s} = \frac{2\pi hc^2}{\lambda^5} \frac{1}{e^{hc/\lambda kT} - 1} = \frac{C_1}{\lambda^5} \frac{1}{e^{C_2/\lambda T} - 1}$$

- c speed of light
- C_1 $3.74 \cdot 10^{-16} \text{ W m}^2$
- C_2 $1.44 \cdot 10^{-2} \text{ K m}$
- h Planck's constant
- k Boltzmann constant

The following illustration shows the graphic description of the formula depending on λ with different temperatures as parameters.

With rising temperatures the maximum of the spectral specific radiation shifts to shorter wavelengths. As the formula is very abstract it cannot be used for many practical applications. But, you may derive various correlations from it. By integrating the spectral radiation intensity for all wavelengths from 0 to infinite you can obtain the emitted radiation value of the body as a whole. This correlation is called Stefan Boltzmann law.

$$M_{\lambda_s} = \sigma \cdot T^4 \text{ [W} \cdot \text{m}^{-2}] \quad \sigma = 5.67 \cdot 10^{-8} \text{ Wm}^{-2} \text{K}^{-4}$$

The entire emitted radiation of a black body within the over-all wavelength range increases proportional to the fourth power of its absolute temperature. The graphic illustration of Planck's law also shows that the wavelength, which is used to generate the maximum of the emitted radiation of a black body, shifts when temperatures change. Wien's displacement law can be derived from Planck's formula by differentiation.

$$\lambda_{\max} \cdot T = 2898 \text{ } \mu\text{m} \cdot \text{K}$$

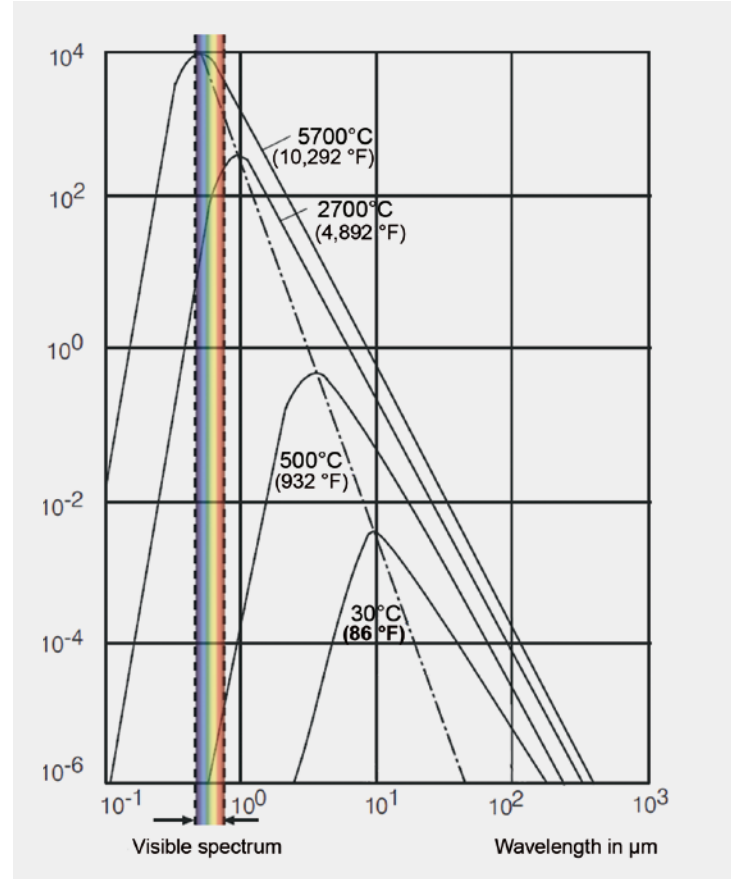

Spectral specific radiation M_{λ_s} of the black body depending on the wavelength

The wavelength, showing the maximum radiation, shifts with increasing temperature towards the range of short wavelengths.

The gray body

Only few bodies meet the ideal of the black body. Many bodies emit far less radiation at the same temperature. The emissivity ϵ defines the relation of the actual radiation value and that of the black body. It is between zero and one. The infrared sensor receives the emitted radiation from the object surface, but also reflected radiation from the surroundings and potentially infrared radiation that has been transmitted through the black body.

$$\epsilon + \rho + \tau = 1$$

ϵ emissivity

ρ reflection

τ transmissivity

Most bodies do not show transmissivity in infrared. Therefore the following applies:

$$\epsilon + \rho = 1$$

Construction and operation of infrared thermometers

The illustration shows the basic construction of an infrared thermometer. Using input optics, the emitted infrared radiation is focused onto an infrared detector. The detector generates an

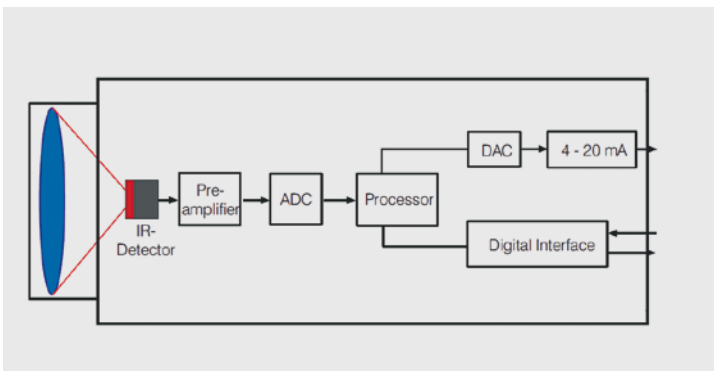

Block diagram of an infrared thermometer

electrical signal that corresponds to the radiation, which is subsequently amplified and can be used for further processing. Digital signal processing transforms the signal into an output value proportional to the object temperature, which is then either shown on a display or provided as an analog signal.

To compensate environmental temperature influences, a second detector records the temperature of the measuring device or its optical channel. The calculation of the temperature of the measuring object is done in three basic steps:

1. Transformation of the received infrared radiation into an electrical signal
2. Compensation of background radiation from device and object
3. Linearization and output of temperature information

In addition to the displayed temperature value, the thermometers also support linear outputs such as 0/4–20 mA, 0–10 V and thermocouple elements, which allow easy connection to process management control systems. Furthermore, due to internal digital measurement processing, most of the currently used infrared thermometers also feature digital interfaces (e.g. USB, RS485, Ethernet) for data output and to enable access to device parameters.

Infrared detectors

The most important element in each infrared thermometer is the radiation receiver, also called detector. There are two main groups of infrared detectors.

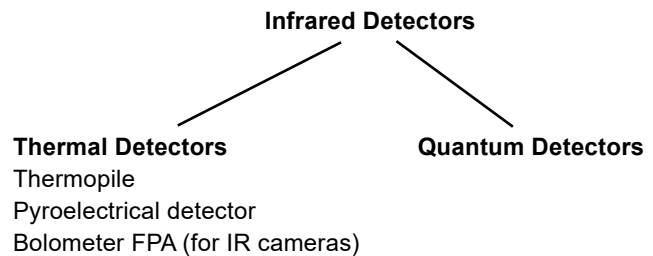

Physical principles

Thermal detectors

With these detectors, the temperature of the sensitive element changes due to the absorption of electromagnetic radiation. The temperature change causes a modification of the temperature-dependent property of the detector, which is electrically analyzed and serves as a measure for the absorbed energy.

Radiation thermocouple elements (thermopiles)

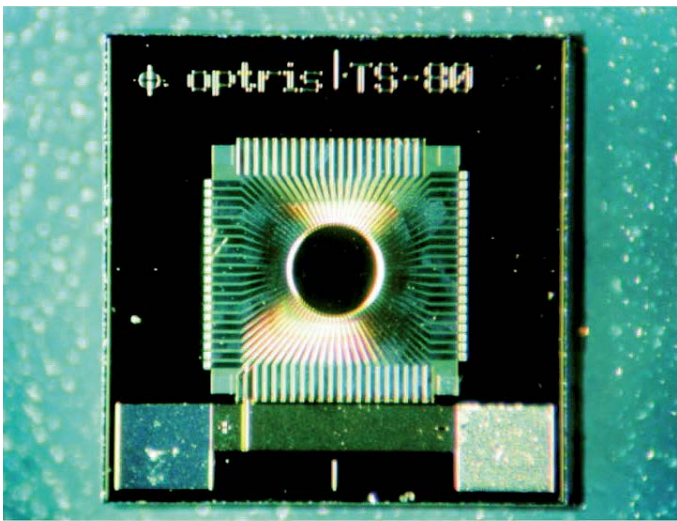

Thermopile TS80

If the connection point between two different metallic materials is heated, the thermoelectrical effect results in an electrical voltage. The contact temperature measurement has been using this effect for a long time with the help of thermocouple elements. If the connection is warm because of absorbed radiation, this component is called radiation thermocouple. The illustration shows thermocouples made of bismuth/antimony which are arranged on a chip round an absorbing element. In case the temperature of the detector increases, this results in a proportional voltage, which can be caught at the end of the bond isles.

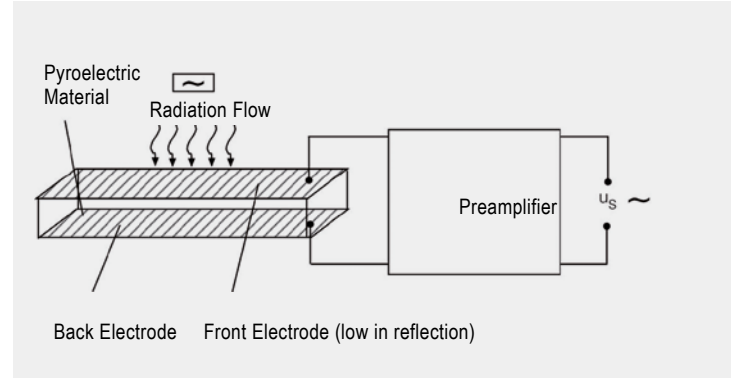

Construction of a pyroelectric detector

Pyroelectric detectors

The illustration shows the basic construction of a pyroelectric detector. This sensitive element consists of pyroelectric material with two electrodes. As a result of the temperature change of the sensitive detector element, caused by the absorption of infrared radiation, the surface loading changes due to the pyroelectric effect. The so created electric output signal is processed by a preamplifier.

Due to the nature of how the loading is generated in the pyroelectric element, the radiation flow has to be continuously and alternately interrupted. The advantage of the frequency selective preamplifying is a better signal-to-noise ratio.

Bolometers

Bolometers exploit the temperature dependency of electric resistance. The sensitive element consists of a resistor, which changes when it absorbs heat. The change in resistance leads to a changed signal voltage. The material should have a high temperature factor of the electrical resistance in order to achieve high sensitivity and high specific detectivity. Bolometers that operate at room temperature use the temperature coefficient of metallic resistors (e.g. black layer and thin layer bolometer) as well as of semiconductor resistors (e.g. thermistor bolometers).

Nowadays, infrared imagers are based on the following technological developments:

The semiconductor technology replaces mechanical scanners. FPAs (Focal Plane Arrays) are produced on the basis of thin layer bolometers. Consequently VOX (Vanadium oxide) or amorphous silicon are used as alternative technologies. These technologies significantly improve the price-performance ratio. Today, common detector sizes are 160 x 120, 320 x 240 and 640 x 480 pixels.

Quantum detectors

The decisive difference between quantum detectors and thermal detectors is their faster reaction on the absorbed radiation. The mode of operation of quantum detectors is based on the photo effect. The visible photons of the infrared radiation lead to an increase of the electrons into a higher energy level inside the semiconductor material. When the electrons fall back, an electric signal (voltage or power) is generated. Also, a change of the electric resistance is possible. These signals can be precisely evaluated. Quantum detectors are very fast (ns to µs).

The temperature of the sensitive element of a thermal detector changes relatively slowly. Time constants of thermal detectors are usually bigger than time constants of quantum detectors. Roughly approximated, one can say that time constants of thermal detectors can be measured in milliseconds whereas time constants of quantum detectors can be measured in nanoseconds or even microseconds.

Despite the fast development in the field of quantum detectors, there are many applications where thermal detectors are more suitable. That is why they share an equal status with quantum detectors.

Transformation of infrared radiation into an electrical signal and calculation of the object temperature

Since per the Stefan Boltzmann law, the electric signal of the detector is as follows:

$$U \sim \varepsilon T_{obj}^4$$

As the reflected ambient radiation and the self-radiation of the infrared thermometer must also be considered, the formula is as follows:

$$U = C \cdot [\varepsilon T_{obj}^4 + (1 - \varepsilon) \cdot T_{amb}^4 - T_{pyr}^4]$$

U	Detector signal
T_{obj}	Object temperature
T_{amb}	Temperature of background radiation
T_{pyr}	Temperature of the device
C	Device-specific constant

$$\rho = 1 - \varepsilon \quad \text{Reflection of object}$$

Since infrared thermometers do not cover the total wavelength range, the exponent n depends on the wavelength λ .

At wavelengths ranging from 1 to 14 µm.

n is between 17 and 2 (at long wavelengths between 2 and 3 and at short wavelengths between 15 and 17).

$$U = C \cdot [\varepsilon T_{obj}^n + (1 - \varepsilon) \cdot T_{amb}^n - T_{pyr}^n]$$

Thus the object temperature is determined as follows:

$$T_{obj} = n \sqrt[n]{\frac{U - C \cdot T_{amb}^n + C \cdot \varepsilon T_{amb}^n + C \cdot T_{pyr}^n}{C \varepsilon}}$$

The results of these calculations for all temperatures are stored as curve band in the EEPROM of the infrared thermometer. This guarantees quick access to the data and fast calculation of the temperature.

Emissivity

The formula shows that the emissivity ε is essential, if you want to determine the temperature with radiation measurement. The emissivity measures the ratio of thermal radiation, which is generated by a gray and a black body of equal temperature. The maximum emissivity for the black body is 1. A gray body is an object, that has the same emissivity at all wavelengths and emits less infrared radiation than a black radiator ($\varepsilon < 1$). Bodies with emissivities, which depend on the temperature as well as on the wavelength, are called non-gray or selective bodies (e.g. metals).

see emissivity table starting page 34

Emissivity and temperature measurement

Emissivity and temperature measurement

Emissivity is a key factor for the accurate measurement of temperatures. It depends on various influences and must be adjusted according to the application.

Theoretically, emissivity depends on the material, its surface, temperature, wavelength, measuring angle and sometimes on the measuring arrangement. Many objects consisting of non-metallic material show high and relatively constant emissivity independent of their surface consistency, at least in long-wave spectral ranges.

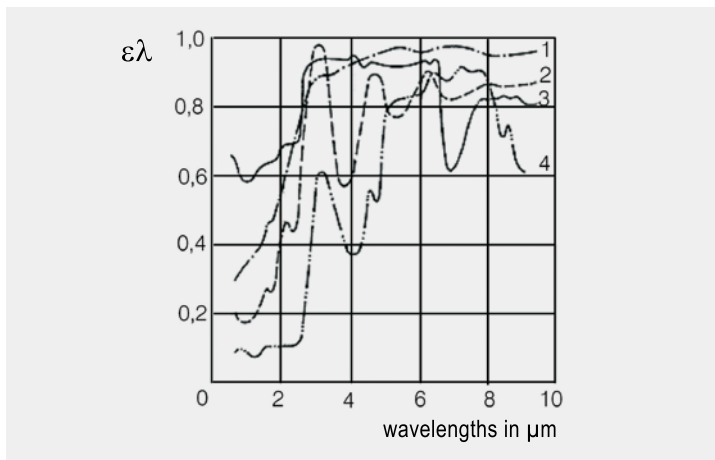

Spectral emissivity of some materials: 1 Enamel, 2 Plaster, 3 Concrete, 4 Chamotte

Generally, metallic materials show a low emissivity, which strongly depends on the surface consistency and which drop in higher wavelengths.

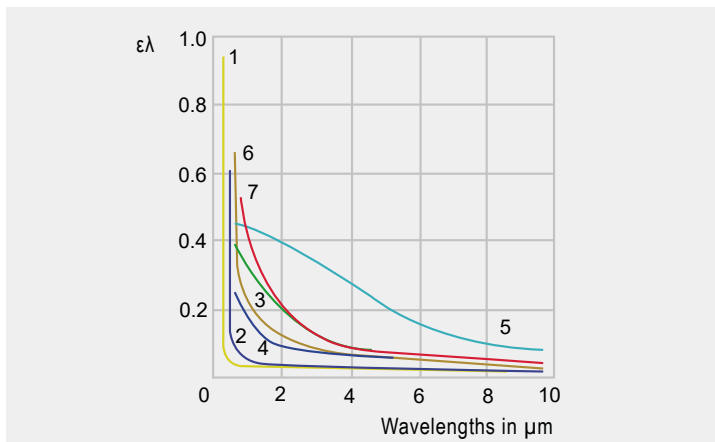

Spectral emissivity of metallic materials: 1 Silver, 2 Gold, 3 Platinum, 4 Rhodium, 5 Chrome, 6 Tantalum, 7 Molybdenum

Temperature measurement of metallic materials

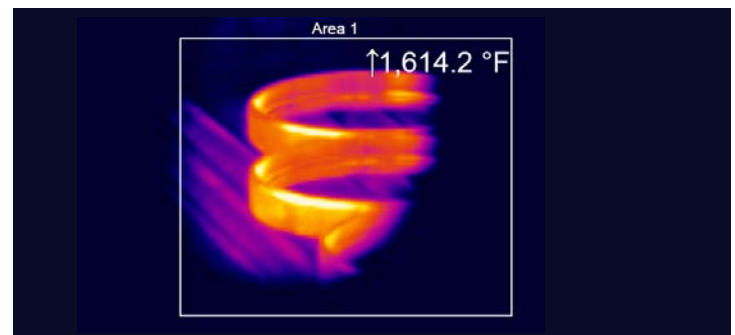

Measurement on bearing rings during hardening process

This may result in varying and unreliable measuring results. When selecting a suitable temperature measurement device, please ensure that the infrared radiation is measured at a specific wavelength and in a specific temperature range, in which metallic materials display a relatively high emissivity. The graph below shows that it makes sense to use the shortest possible wavelength available for measuring, since measuring errors increase in correlation to the wavelength for many types of metals. For metals, the optimal wavelength at high temperatures is 0.8 to 1.0 μm , which lies at the limit of the visible area. In addition, wavelengths of 1.6 μm , 2.2 μm and 3.9 μm are possible.

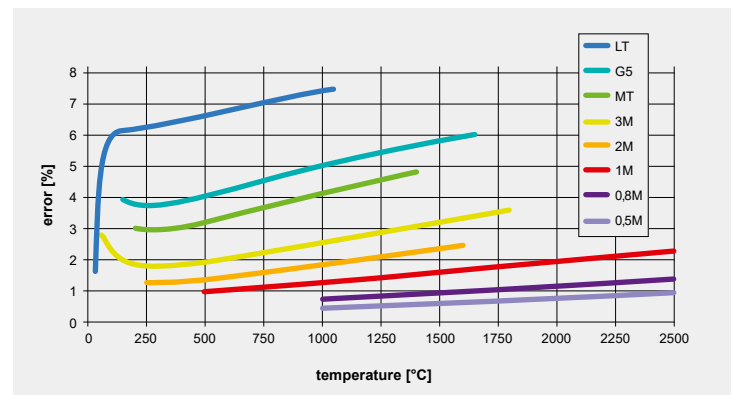

Measurement error due the emissivity being wrongly adjusted by 10 % in dependence on wavelength and object temperature (LT: 8–14 μm ; G5: 5 μm ; MT: 3.9 μm ; 3M: 2.3 μm ; 2M: 1.6 μm ; 1M: 1.0 μm); 0.8M: 800 nm; 0.5M: 525 nm.

Temperature measurement of plastics

Transmission rates of plastics vary according to wavelength. They react inversely proportional to the thickness, whereas thin materials are more transmissive than thick plastics. Optimal measurements can be carried out with wavelengths, where transmissivity is almost zero. Independent of the thickness. Polyethylene, polypropylene, nylon and polystyrene are non-transmissive at 3.43 μm ; polyester, polyurethane, PTFE, FEP and polyamide are non-transmissive at 7.9 μm . For thicker and pigmented films, wavelengths between 8 and 14 μm can be selected.

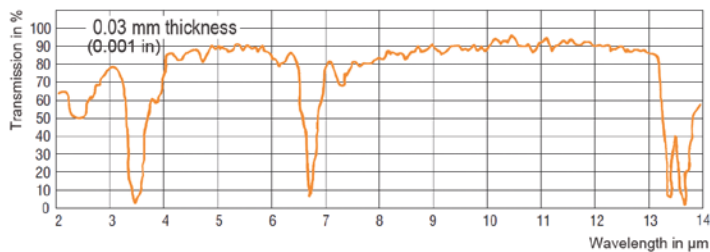

Spectral transmissivity of plastic films made from polyethylene

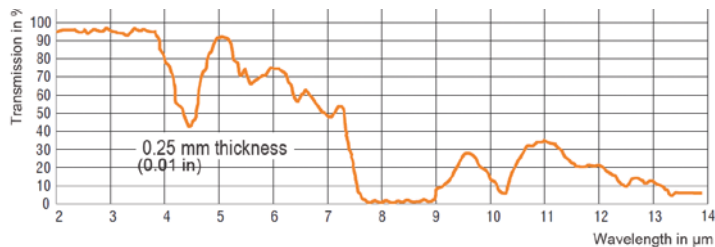

Spectral transmissivity of plastic films made of polyester

The manufacturer of infrared thermometers can determine the optimal spectral range for the temperature measurement by testing the plastics material. The reflection is between 5 and 10 % for almost all plastics.

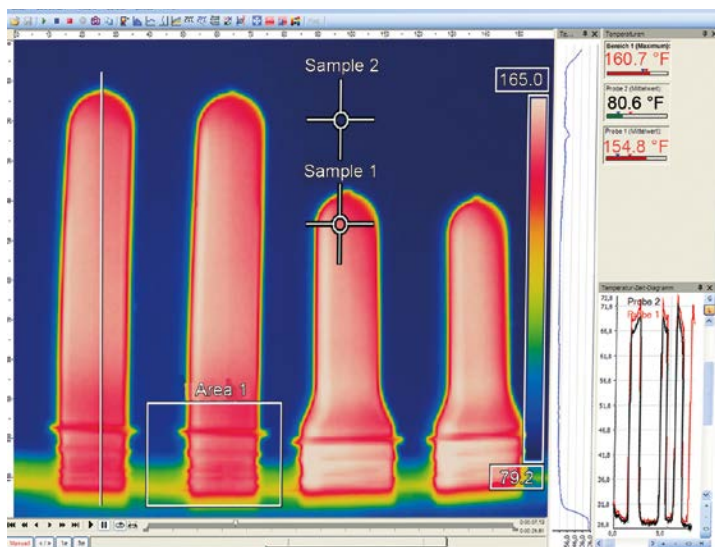

Detailed analysis of preforms during bottle manufacturing

Further information on plastics applications can be found in the brochure:

www.optris.com/plastics

Temperature measurement of glass

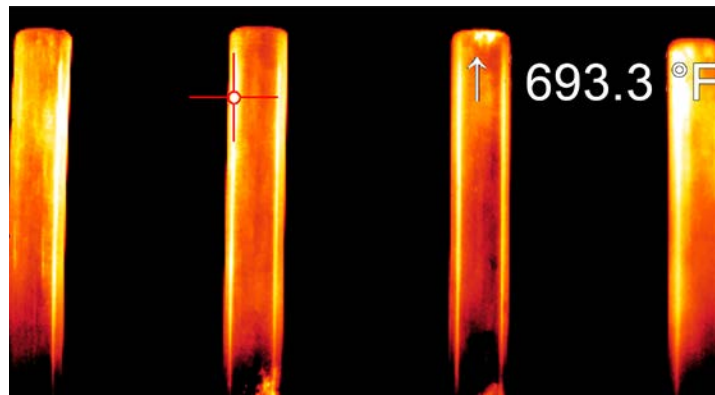

Hot spot measurement on glass tubes

If temperature measurements are performed on glass with IR thermometers or the special IR camera PI G7, both reflection and transmissivity must be considered. A careful selection of the wavelength facilitates measurements of the glass surface as well as of the deeper layers of the glass. Wavelengths of 1.0 μm , 2.2 μm or 3.9 μm are appropriate for measuring deeper layers, whereas 5 μm and 7.9 μm are recommended for surface measurements. At low temperatures, wavelengths between 8 and 14 μm should be selected in combination with an emissivity of 0.85 in order to compensate reflection. For this purpose, a thermometer with short response time should be used, since glass is a poor heat conductor and the surface temperature can change quickly.

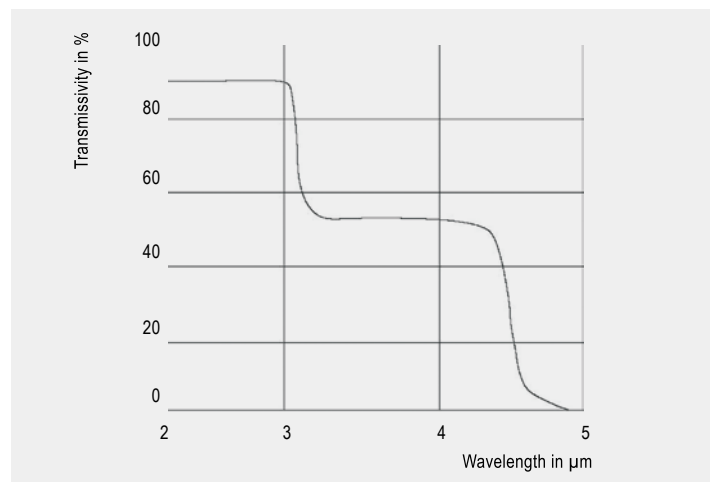

Spectral transmissivity of glass

Further information can be found in the glass applications overview:

www.optris.com/temperature-monitoring-glass-industry

Emissivity and temperature measurement

Environmental influences

The chart below shows that the transmissivity of air strongly depends on the wavelength. Areas of high damping alternate with areas of high transmissivity – the so-called atmospheric windows. The transmissivity in the long-wave atmospheric window (8–14 μm) is constantly high, whereas, due to the atmosphere, there are measurable reductions in the shortwave area, which may lead to false results. Typical measuring windows are 1.1 ... 1.7 μm , 2 ... 2.5 μm and 3 ... 5 μm .

Additional influencing variables are potential from heat sources in the environment of the measuring object. To prevent wrong measuring results due to increased ambient temperatures, the infrared thermometer compensates the influence of ambient temperatures beforehand (e.g. when measuring temperatures of metals in industrial ovens, where the oven walls are hotter than the measuring object). A second temperature measuring head helps to generate accurate measuring results by automatically compensating the ambient temperatures and correctly adjusting emissivity.

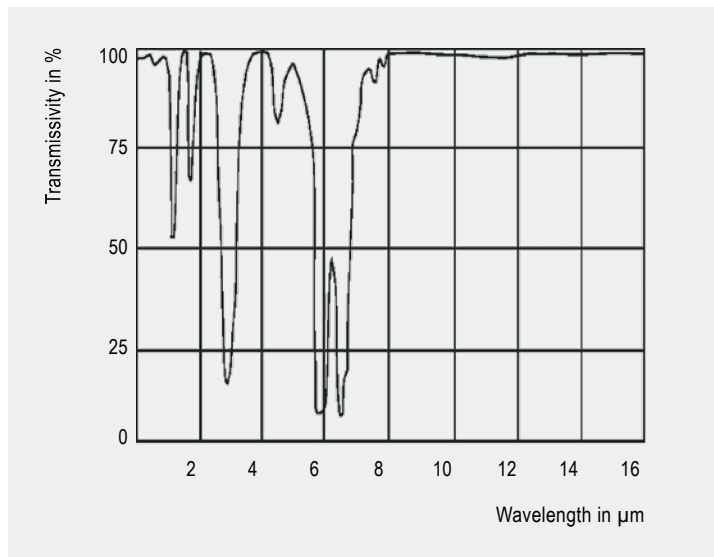

Spectral transmissivity of air (1 m, 32 °C (90 °F), 75 % r. F.)

Dust, smoke and suspended matter in the atmosphere can pollute the lens and result in false measuring results. The use of air purge units (screw-on pipe socket connections with compressed air) prevents particles in the air from collecting on the lens. Accessories for air and water cooling support the use of infrared thermometers even under harsh environmental conditions.

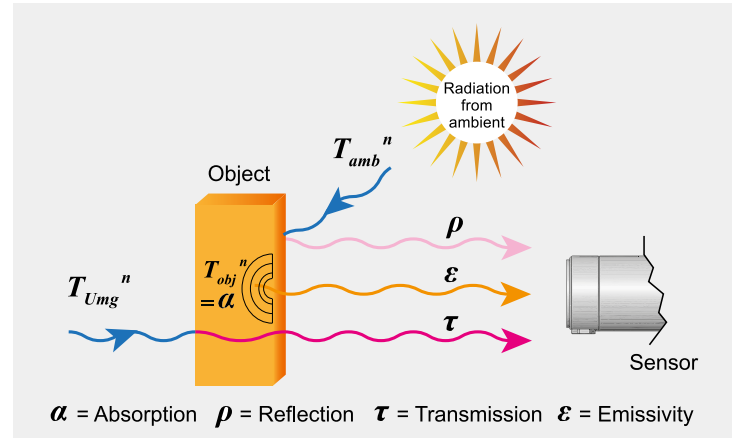

Compensating ambient influences

Experimental determination of emissivity

In the appendix you will find emissivity data for various materials from technical literature and measurement results. There are different ways to determine emissivity.

Method 1: With the help of a thermocouple:

With the help of a contact probe (thermocouple), the real temperature of an object surface is measured simultaneously to the radiation. The emissivity is subsequently adjusted so that the temperature measurement of the infrared thermometer corresponds to the value shown by the contact measurement. The contact probe should have good temperature contact and only low heat dissipation.

Method 2: Creating a black body with a test object from the measuring material:

A drilled hole (ratio diameter to drilling depth $\leq \frac{1}{3}$) in thermal conducting material reacts similarly to a black body with an emissivity near 1. It is necessary to aim at the bottom of the drilled hole due to the optical properties of the infrared device and the measuring distance. Emissivity can be subsequently determined.

Method 3: Applying reference emissivity:

A band or color with a known emissivity is applied to the measurement object. This emissivity is set on the infrared measurement device and the temperature of band or paint can be measured. Subsequently, the temperature next to this reference point will be measured, whereby the emissivity must simultaneously be adjusted until the same temperature measurement of the band or paint is displayed. Emissivity is subsequently displayed on the device.

Calibration of infrared thermometers^{[1] [2]}

Infrared temperature measuring devices are calibrated with the aid of black bodies. These radiation sources can produce different temperatures with a high degree of stability (also see page 5, section on black bodies). For the calibration process it is important to know the exact value of the radiation temperature. The value is measured either using a contact thermometer or with a transfer normal radiation thermometer, and then used for adjusting/calibrating the infrared sensors. For calibration by the customer or by an accredited calibration laboratory, the calibration temperatures should be in the range of the temperature which occur in the relevant application.

The transfer normal radiation thermometers LS-PTB, CTlaser 2MH SF-PTB and Exactus Optical Thermometer-PTB are used for measuring the radiation temperature of the reference sources.

Based on the pyrometer PTB, one can produce a high precision reference infrared thermometer for the customer. The DCI devices are manufactured with preselected components, which guarantee high stability measurement. In combination with a special calibration at three calibration points, a higher accuracy can be provided for the temperature measurement of the DCI CTlaser LT at these reference points.



Certificate of German National Metrological Institute (PTB)



transfer standard radiation thermometer CT-PTB

Emissivity and temperature measurement

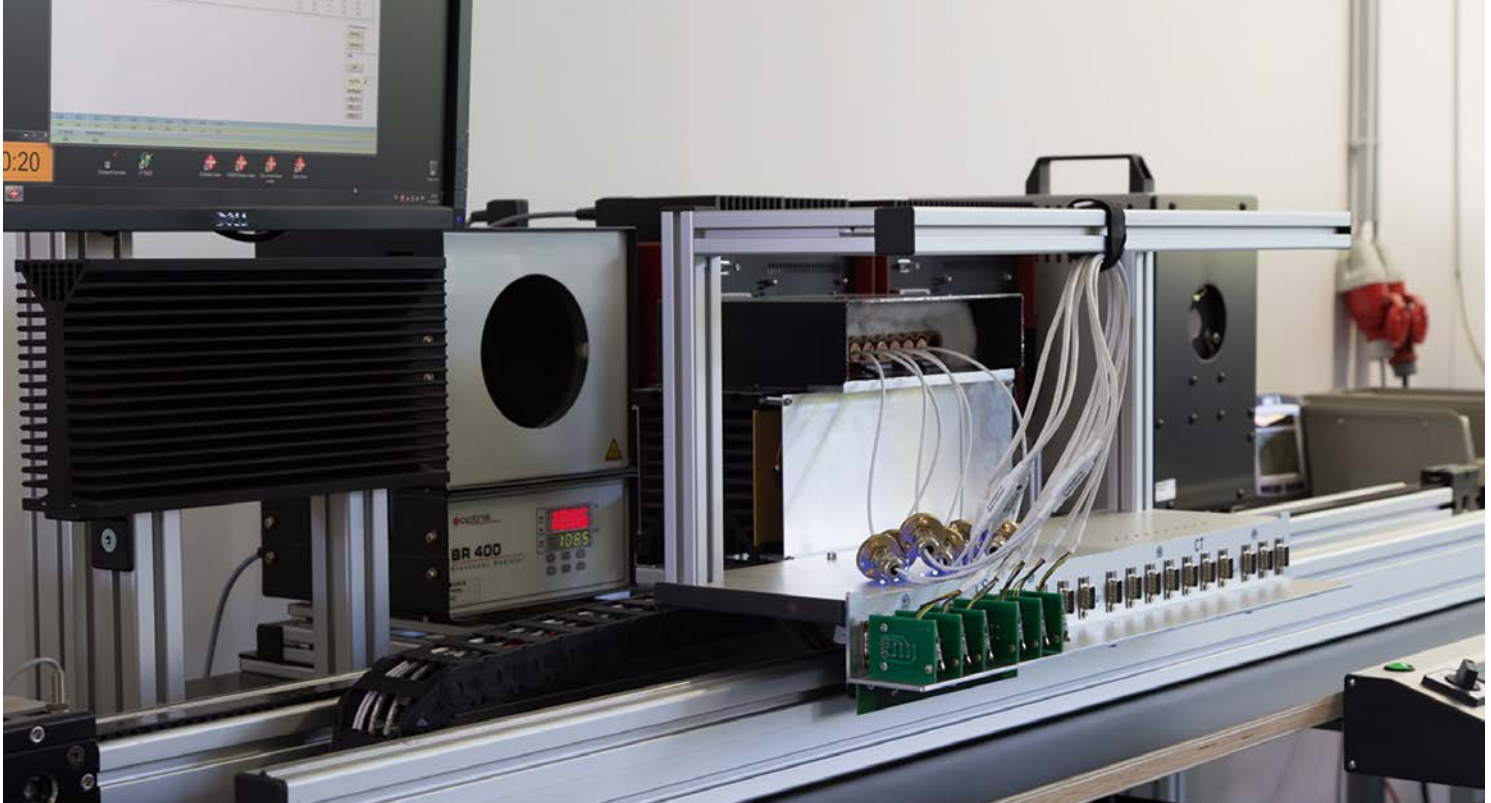

Automated calibration station

The optics of infrared temperature measurement devices are generally described by the ratio between measurement distance (D) and the measurement field diameter (S), ($D:S$).

Depending on the quality of the optics, the measurement device however will also receive portions of radiation from outside this specified measuring field. Here the maximum value equates to the radiation which is emitted by a hemispherical radiation source (hemisphere). The corresponding signal change together with the changing value of the radiation source is described by the SSE: Size-of-Source Effect.

As a result of these relationships, all manufacturers of infrared temperature measurement devices used fixed defined geometries for calibration, i.e. a distance to the reference body is set based on the opening diameter of the radiation source.

From the technical documentation it can be seen that for the measurement field size of the devices, a defined percent value of the previously mentioned maximum is provided - typical values here are 90% or 95%.

When preparing calibration certificates, in addition to the room temperature and air humidity of the calibration laboratory, the measurement distance and the diameter of the radiation body opening (calibration geometry) is also recorded.



Not only are high technical standards applied to the production of measuring devices, but also in the active participation in sector wide standardization processes. At the moment development engineers are working, among other areas, in the working groups for Applied Radiation Thermometry (GMA 8.1) and Temperature Measurement with Thermal Imaging Cameras (GMA 8.16) of the Verein Deutscher Ingenieure (VDI).

Optics, sighting techniques and electronics of infrared pyrometers

Construction of the infrared thermometers

Infrared thermometers have various configurations and designs, which differ in optics, electronics, technology, size and housing. Despite these differences, the signal-processing chain is always the same: It starts with an infrared signal and ends with an electronic temperature output signal.

Lenses and windows

The measuring chain begins with an optical system – usually consisting of lens optics. The lens receives the emitted infrared energy from a measuring spot and focuses it onto a detector. Measurements based on this technology can only be correct, if the measuring object is bigger in size than the detector spot. The distance ratio describes the size of the measuring spot at a specific distance. It is defined as D:S-ratio: relation of measuring distance to spot diameter. The optical resolution improves with increasing values of the D:S ratio.

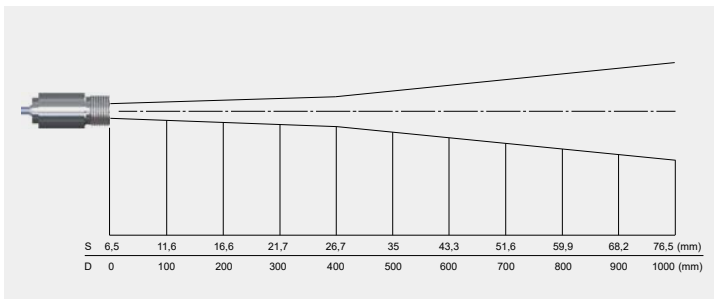

Optical diagram of an infrared sensor CT

Depending on their material, infrared lenses can only be used for a certain wavelength range. The following chart presents typical lenses and window materials for infrared thermometers with their corresponding wavelength.

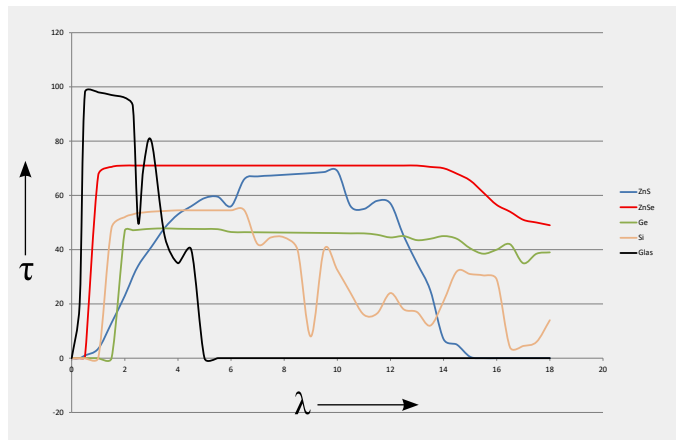

Transmissivity of typical infrared materials (1 mm thick) glass, germanium (Ge), silicon (Si), zinc sulfide (ZnS), zinc selenide (ZnSe)

Some measurements make it necessary to take the temperature through an appropriate measuring window, as in closed reaction containers, ovens or vacuum chambers. The transmissivity of the measuring window should match the spectral sensitivity of the sensor. Quartz glass is suitable for high measuring temperatures, while special materials like germanium, AMTIR or zinc selenide should be used for low temperatures in the spectral range between 8 – 14 μm . The following parameters should also be considered when selecting a window: diameter of the window, temperature conditions and maximum pressure difference. A window of 25 mm in diameter, which has to resist a pressure difference of 1 unit of atmosphere, should be 1.7 mm thick. To focus the sensor on the measuring object for measurements in, for example, a vacuum container, it makes sense to use window material, that is also transparent in the visible range.

Optics, sighting techniques and electronics of infrared pyrometers

Window Materials / Properties	Al ₂ O ₃	SiO ₂	CaF ₂	BaF ₂	ZnS	ZnSe	KRS ₃	GE	Si
Recommended infrared wavelength in μm	1 ... 4	1 ... 2.5	2 ... 8	2 ... 8	2 ... 14	2 ... 14	1 ... 14	2 ... 14	1.5 ... 8
Max. window temperature in °C	1800	900	600	500	250	250	no info	100	200
Transmissivity in visible area	yes	yes	yes	yes	yes	yes	yes	no	no
Resistance against humidity, acids, ammonia compound	very good	very good	few	few	good	good	good	good	very good
Appropriate for UHV	yes	yes	yes	yes	yes	yes	yes	yes	yes

The table presents a comparative overview of various window materials.

Windows with anti-reflection coating have significantly higher transmissivity (up to 95 %). The transmission loss can be corrected with transmissivity adjustment on the window, providing that the manufacturer has specified transmissivity for the corresponding wavelength range. Otherwise, it must be experimentally determined with an infrared thermometer and a reference source.

Latest trends in sighting techniques

New measuring principles and sighting techniques enable greater accuracy in the use of infrared measuring devices. Innovations in the field of solid state lasers are adapted by using multiple laser systems to mark spot sizes. As a result, actual spot sizes inside the object field are displayed using laser crosshair technology. In other devices, video camera chips replace optical sighting systems.

Development of high-performance optics in combination with crosshair laser sighting technologies.

Simple, cost-effective portable infrared thermometers use single spot laser pointers in order to mark the center of the spot with a parallax default. Applying this technique, the user has to estimate the spot size with the help of the spot size diagram and the likewise estimated measuring distance.

If the measuring object covers only a part of the measuring spot, temperature rises are only displayed as an average value of hot area and ambient cold area. If, for example, the higher resistance of an electric connection due to a corroded contact results in an overheating, this rise in temperature will only be shown as minor heating for smaller objects and oversized spot dimensions, and the potential danger of the situation will not be recognized.

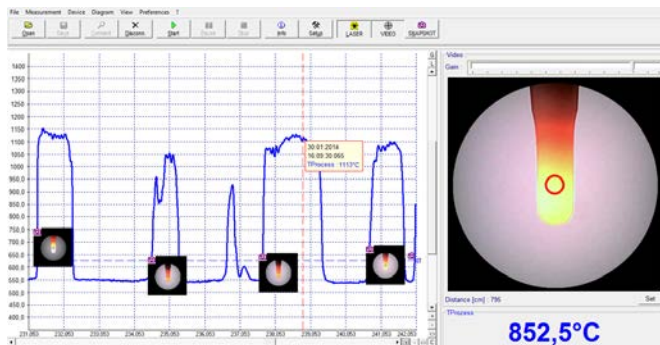

The Compact Connect software features extensive setting options for the video pyrometer.

The new double laser concept

The double laser sight helps when aiming the sensor. The laser is adjusted in such a way that the infrared measurement spot is located within the two laser dots. At the focal point of the relevant optics both laser points lie over each other thereby marking the minimum measuring point as a single laser point. This allows the sensor to be positioned exactly onto the object to be measured.

The crosshair principle of the video pyrometer

By using new laser lighting technologies we have succeeded in presenting the measuring spot of infrared thermometers with the aid of a visible crosshair.

Here, two laser diodes arranged at 90° angles around the infrared optical measuring channel have been fitted with line generators. This means the laser lines produce a crosshair on the object plane, which always precisely marks the center of the measuring spot independent of the distance to the subject.

With the aid of this technology it is possible for the first time to mark the center of the measuring point with a laser, which does not come from the center of the optics. As well as design advantages, this brings an improvement of the practical usability of devices with good optical performance capabilities.

Fixed vs. flexible focus

Many infrared thermometers have a so-called fixed focus, i.e. the optics are focused for a certain measuring distance. This means the user looks for the version which is more or less correct for his application from a multitude of various focal options. It is still possible to measure accurately outside the preset measuring distance, however in these areas the optical resolution (D:S ratio) is then poorer. Because this always applies only for the specific focal length.

Infrared thermometers with variable focus allow users to focus the desired measurement distance continuously as required. This has the advantage that it is possible to use the best optical resolution of the device in all cases, since the D:S ratio here applies for each focused measurement distance. This means that these kinds of infrared thermometers can also be used for varying measuring distances or object sizes by simply adjusting to the new measuring task.

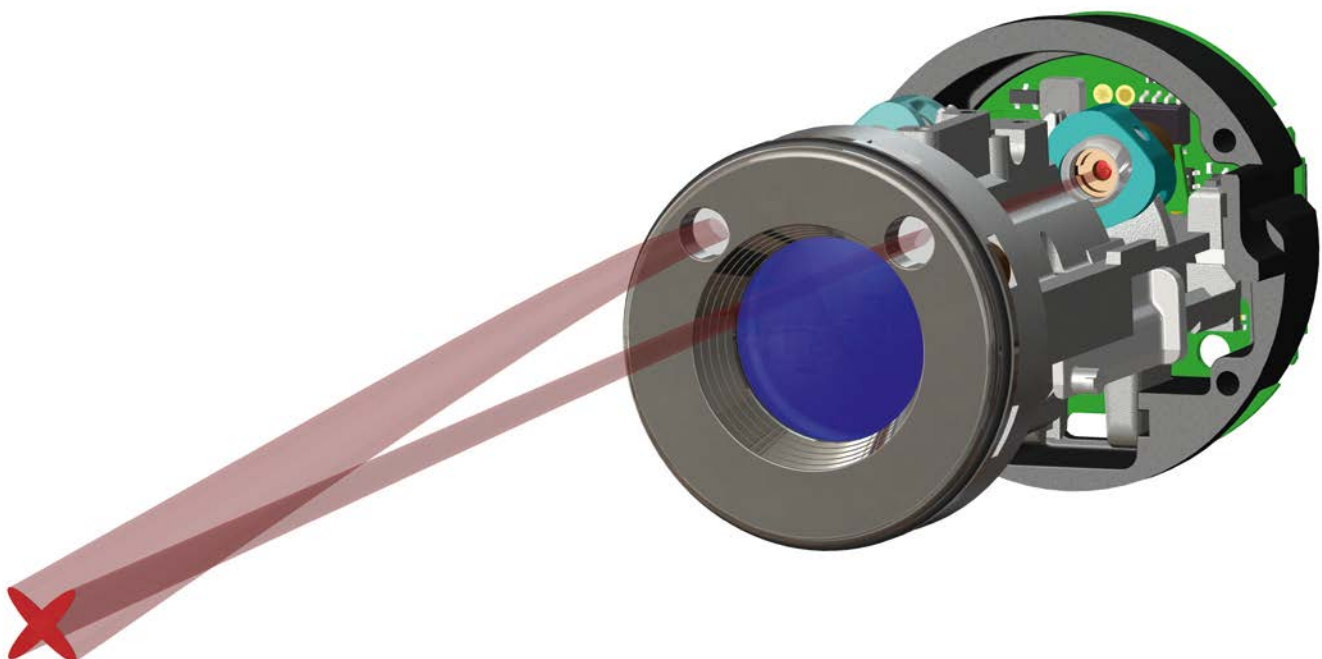

Innovative crosshair principle of video pyrometer

Optics, sighting techniques and electronics of infrared pyrometers

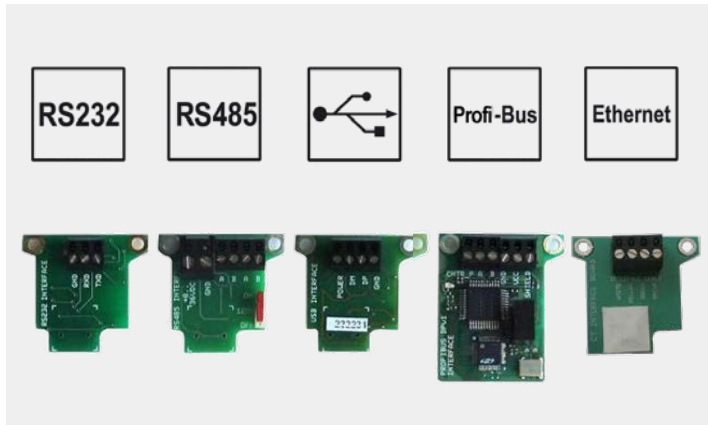

Outputs and interfaces (analog and digital).
As an example: pluggable, digital interface modules of the electronic box

In order to correctly display spot size, optical sighting systems were developed with size marking in the crosshairs, which enable precise targeting. Since laser pyrometers are significantly easier and safer than contact thermometers, engineers have tried to mark the spot size with laser sighting techniques independently from the distance – according to the distance-spot-size ratio in the diagram.

Two warped laser beams approximately show the narrowing of the measuring beam and its broadening in longer distances. However, the diameter of the spot size is only indicated by two spots on the outer circumference. Due to the design, the angle position of these laser points on the measuring circuit moves, which makes aiming difficult.

One advancement are video pyrometers, which enable precise measuring field marking with help of a simultaneous use of a video module and a crosshair laser sighting technology.

Electronics

Displays, outputs and interfaces

The electronics of the infrared thermometer linearizes the output signal of the detector to ultimately generate a linear power signal 0/4 – 20 mA or voltage signal 0 – 10 V. The portable thermometers show this signal as a temperature result on the LCD displays. Additionally, some of the portable units as well as online sensors offer various outputs and interfaces for further signal processing.

The output interfaces of infrared thermometers may be directly connected with PC, laptop, measuring data printer. Custom-specific graphics and charts can be created with PC software.

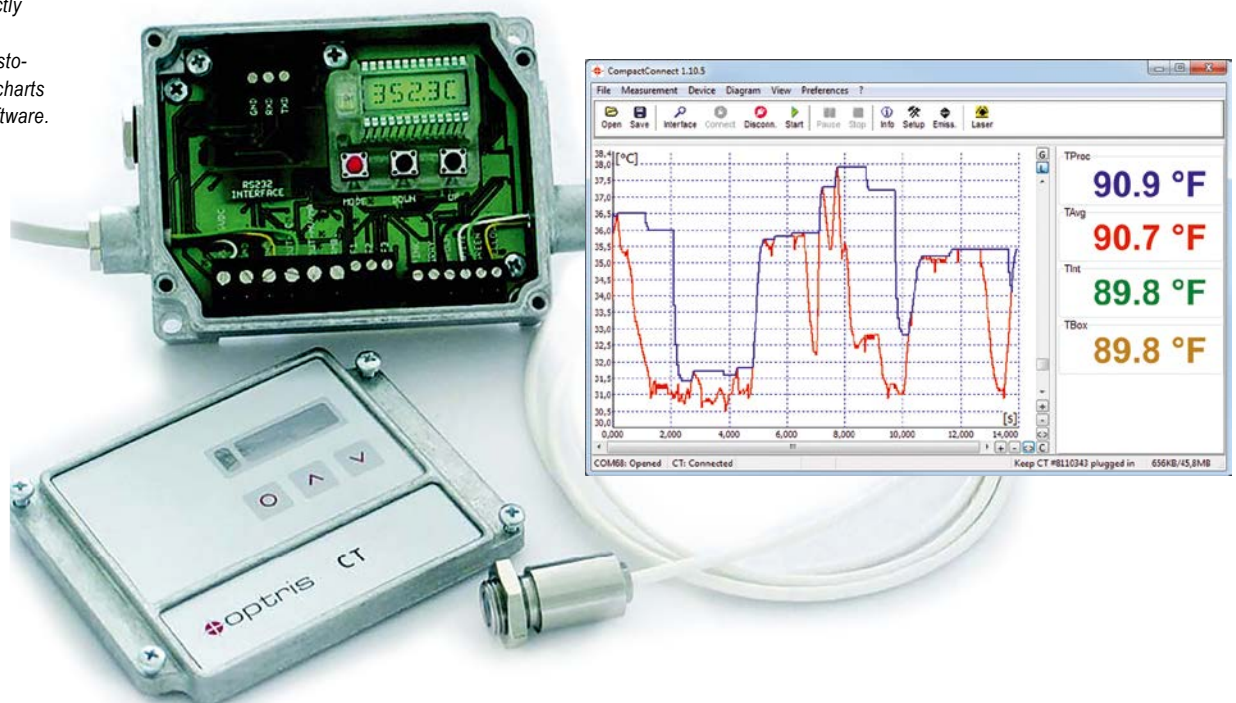

Sensors and applications of non-contact measurement

Non-contact temperature measurement with infrared thermometers is a qualified method of controlling, monitoring and managing process temperatures and of preventive maintenance of machines and facilities. Portable infrared thermometers or infrared online sensors are categorized as point and image measuring devices, and can be selected depending on the application.

Infrared cameras

A camera is designed to take images of the surroundings - these may be moving or static. Whilst traditional cameras gather light which is visible for the human eye, infrared cameras work in a higher wavelength region, in order to measure the temperature of the surface based on the detected radiation. The images taken in this way can be recalculated to present a temperature image of the recorded object. A false color representation allows the various temperatures to be visualized using various colors in a clear way. This allows the user to identify warm or cold areas very easily based on the image. Using associated software, the infrared cameras can take on different applications, so for example detecting hotspots or line scanning through tiny slits. The applications of infrared cameras are very varied and range from the maintenance of electrical equipment through quality assurance of workpieces and on to the control of processes in various industrial sectors. Depending on the application, cameras with different optics, resolutions and image frequencies are available.



Infrared thermometers/ pyrometers

Infrared thermometers or pyrometers can carry out a non-contact temperature measurement of an object at a single point. Infrared thermometers are very compact and can be integrated easily into a wide range of application environments. Devices are available which can be selected based on temperature ranges and wavelengths, and which can be adapted to the industrial application. Pyrometers are distinguished between the compact, low price sensors (compact series) and the high-performance thermometers (high-performance series). Both series can output measuring values via various standard interfaces, thereby allowing them to be used directly for process control. Typical applications for infrared thermometers can be found in many industrial processes, where maintaining an exact temperature is important, for example in the plastics and metal industries or in the manufacture of cardboard packaging.



With the IRmobile App you can monitor and analyze your infrared temperature measurement directly on a connected smartphone. All you need is an Optris infrared camera or a pyrometer and an Android device from version 5.0.



available on Google Play

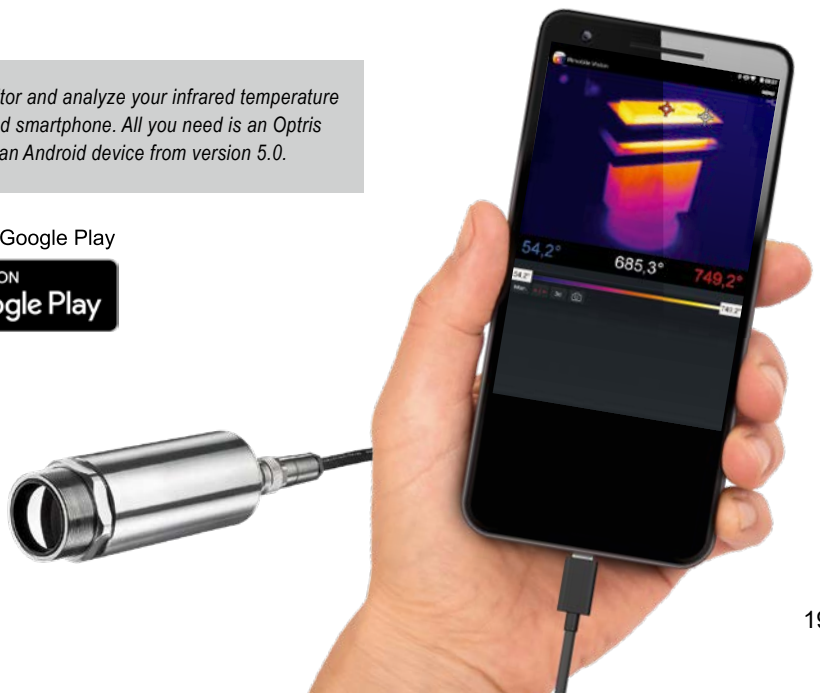

Infrared cameras and applications

Infrared cameras and applications

Seeing localized hotspots thereby allowing weaknesses in our environment to be detected has always been the fascinating aspect of modern thermal imaging. Not least due to the constantly more effective methods of manufacturing the IR optical image sensors, infrared cameras have undergone a drastic improvement in their price/performance ratio.

The devices have become smaller, more robust, and with lower energy consumption. For some time now there have been thermographic measuring systems which, similar to a webcam, only need a USB port to operate them.

infrared camera optics

Infrared cameras work like normal digital cameras: They have a field of view, which can be between 6° (tele) and 90° (wide-angle). The further you are from the object, the larger the image area which is captured and therefore however also the larger the image section covered by one pixel. The advantage of these conditions is that the lighting intensity is independent of distance on sufficiently large surfaces. This means that temperature measurements are generally unaffected by the distance to the measuring object. [1]

Thermal radiation can only be focused in the long-range infrared region (8-14 μm) using optics made of germanium, germanium alloys, zinc salts or surface mirrors.

Compared to the mass-produced lenses we are used to from the visible range of the spectrum, these kinds of specialized lenses are still a considerable cost factor for thermal imaging cameras. They are designed as spherical 3-lens or aspherical 2-lens optics

and must be calibrated for thermometrically correct measurements, particularly for cameras with lenses which are exchangeable, due to their influence on the individual pixels.

Optics calculator for infrared cameras



available on Google Play

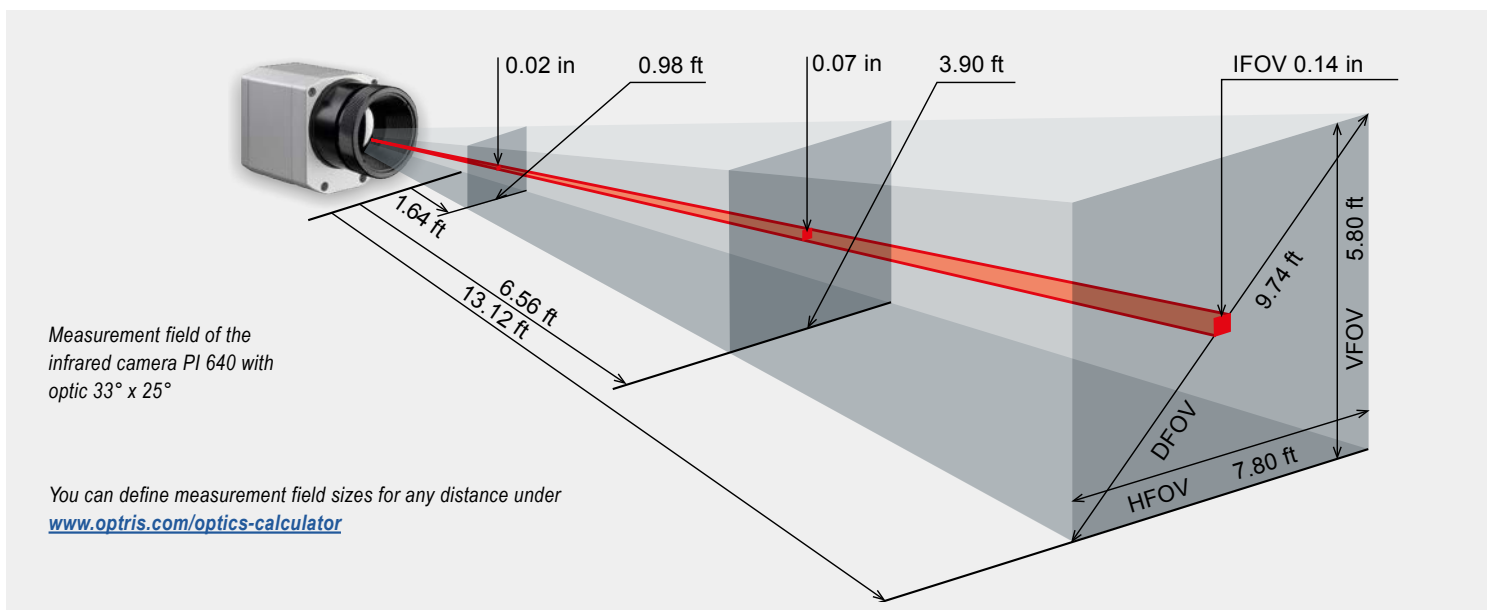
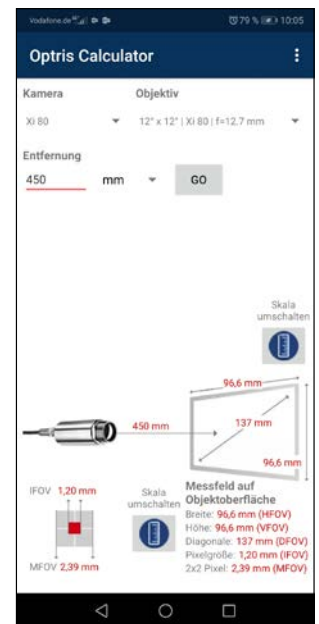

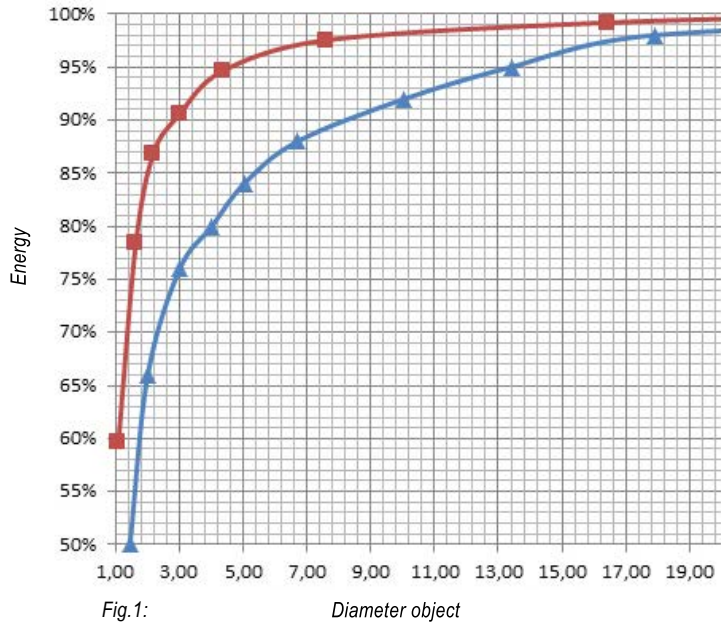

Fig.1:

Diameter object

Geometric resolution for ideal temperature measurement

When designing optics for measuring IR cameras, special attention must be paid to the quality of detail contrast with which an object can be represented in the image. This is described by the modulation transfer function (MTF). Since in contrast to visual cameras, with IR cameras the thermal contrast is of more interest, this is used together with the slit response function (SRF). The result is determined by the number of pixels an object needs to fill to allow its temperature to be measured exactly. In high-performance infrared optical systems, this is 3x3 pixels (red curve;fig. 1), with lower quality optical systems, in some circumstances as many as 10x10 pixels may be required (blue curve,fig xx), to receive 90% of the energy. A high-performance camera lens also allows a larger measuring distance with the same number of pixels of the detector, or the precise temperature measurement of smaller structures and objects. The 3x3 pixel geometry is described as MFOV (measurement field of view) - one single pixel on the object surface is described as IFOV (instantaneous field of view). The MFOV is comparable with the measuring spot definition with infrared thermometers.

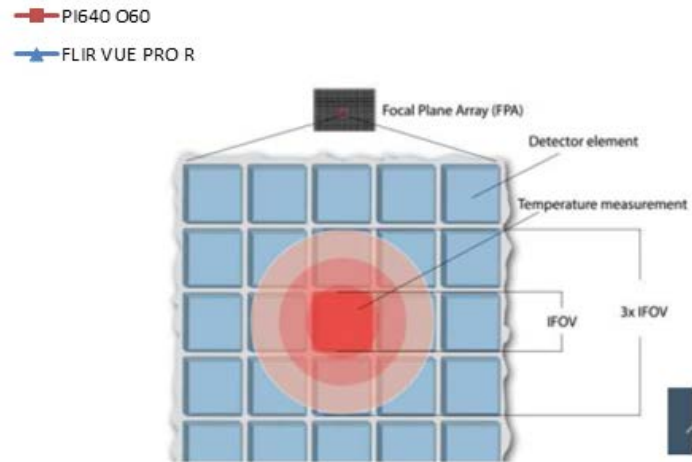

Fig.2:

The heart of the infrared camera in the vast majority of all thermographic systems used in the world is a focal plane array (FPA). FPAs are integrated image sensors with sizes of 6400 up to 1 million pixels. Each pixel itself is a microbolometer with a size of 12 x 12 up to 35 x 35 μm^2 . These 150 nanometer thick, thermal receivers are heated by the thermal radiation within 10 ms by around a fifth of the temperature difference between object and own temperature. Such high-sensitivity is achieved through an extremely low heat capacity in conjunction with superb insulation to the evacuated environment. The absorptivity of the partially transparent receiver surface is increased by interference of the transmitted light wave which is subsequently reflected onto the surface of the silicon chip with the following light wave. [3]

To utilize this inherent interference effect, the bolometer surface, which consists of vanadium oxide or amorphous silicon, must be positioned using special etching techniques at around 2 μm distance from the readout circuit. The area- and bandwidth-related specific detectivity of the FPAs as described here reach values around 109 $\text{cm Hz}^{1/2}/\text{W}$. Thus they are an order of magnitude more sensitive than other thermal sensors, as used for example in pyrometers.

The temperature of the bolometer changes its resistance in turn, which is converted into an electrical voltage signal. Rapid 14 bit A/D converters digitize the previously amplified and serialized video signal. A digital signal processor calculates temperature values for each individual pixel and produces the well-known false color image in real time. Infrared cameras require a rather complex calibration, where for each pixel at different chip or black body temperatures a series of sensitivity values is assigned. To increase the measurement precision the bolometer FPAs are thermostated at defined temperatures with a large control accuracy.

Infrared cameras and applications

Due to the development of constantly more powerful, smaller and at the same time lower cost laptops, netbooks, tablet PCs and smartphones, it is now possible to use their

- Large displays for showing thermal images,
- Optimized Li-ion batteries for power supply,
- Computing power for flexible and high-quality real-time signal presentation,
- Storage capacity for currently virtually unlimited thermal imaging video recording as well as
- Ethernet, Bluetooth, Wi-Fi and software interfaces for integrating the thermography system into the application environment.

The standardized, universally available USB 2.0 interface allows data transfer rates of e.g.

- 32 Hz with 640 × 480 pixel resolution,
- 125 Hz with 640 x 120 pixel (subframe mode)
- 1 kHz with 72 x 56 Pixels.

USB 3.0 technology is even suitable for XGA thermal imaging resolutions up to 100 Hz video frequency. By using the webcam principle in thermographic imaging, completely new product features are available with a significantly improved price/performance ratio.

Here the infrared camera is connected through the 480 MBaud interface with the Windows-based computer, which at the same time provides a power supply.

The hardware of USB infrared cameras

The Compact Line is a fusion of the robust, compact pyrometers with modern IR cameras. One of the special features of this low-budget camera is the possibility to set the focal point remotely using a motor drive focus, and to integrate the camera autonomously - without a process computer - into the process via an analog output. The new feature here, is that a hotspot can also be issued as an analog output.

Modern USB infrared cameras unify the advantages of compact and robust pyrometers and compact IR cameras. As well as a remote adjustment option for the focal point via the integrated motor drive focus, these cameras can also work autonomously - i.e. without a process computer. The IR camera then calculates the hotspot within the recorded object field itself for example, and therefore is capable of following moving objects. The calculated temperature of the object followed is output directly as an analog 0/4-20 mA signal.

In the past USB was a purely office communication interface. The widespread use of this interface standard compared to FireWire initiated numerous developments, which have considerably improved the industrial capabilities of the interface and therefore the usability of USB 2.0 devices.



Infrared cameras up to 640 x 480 pixels and 1.000 Hz

These include:

- Trailing-cable capable which can be used at up to 200 °C (392 °F) with cable lengths up to 10 m. [4]
- Up to 100 m Cat. 6 (Ethernet) – via USB to GigE-converter (PoE-capable)
- Optical fiber optic ethernet modems for cable lengths up to 10 km

Due to the high bandwidth of the USB bus, for example five 120 Hz infrared cameras can be connected using a standard hub over a 100 m ethernet cable with a laptop.

The waterproof, vibration and shock resistant thermal imaging devices conform to protection class IP 67 and are therefore also suitable for use for robust test and inspection bench applications. 45 x 45 x 60-75 mm³ size and 195 g considerably reduce the cost for cooled housings and air purge units.

Due to the thermal drift of bolometers and their on-chip signal processing, all globally sold measuring infrared cameras require an offset correction at certain time intervals. A black coated metallic part is moved in front of the image sensor by a motor for this purpose. This references each image element with the same known temperature. Naturally during this kind of offset calibration, thermal imaging cameras are blind. To minimize this effect, the offset correction can be initiated at a suitable point in time using an external control pin. At the same time the cameras have been designed in such a way that the duration of the auto calibration is kept as short as possible.

The installation of suitably fast actuators allows auto referencing within 250 ms with the USB infrared cameras. This is comparable with the duration of closing and opening an eyelid, and therefore acceptable for many measuring processes. With continuous processes, where sudden hotspots must be detected, often „good“ reference images generated close together can be used within a dynamic differential image measurement. This allows continuous operation without a mechanically moving element.

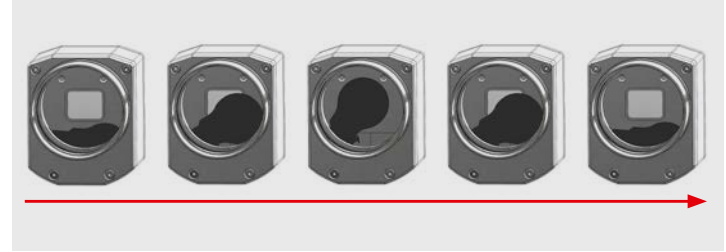

For offset referencing, a temperature reference is briefly moved into the field of view of the infrared sensor array.

Particularly when using the longwave spectral sensitive cameras in the 10.6 μm CO₂ laser processing technology, the option for an externally controlled closure of the optical channel while at the same time having independent signals from the optomechanically protected operating condition of the camera has become well proven. There are also special CO₂ blocking filters however, which also allow temperature measurement using these IR cameras even with an active CO₂ laser.

For machining lasers, which work in the range of 900 nm to 2.6 μm, long-wave IR cameras can be used without additional filters, since the good blocking effect of the spectral filter on the detector is sufficient. With higher process temperatures and with metallic surfaces, it is preferable however to use short-wave cameras. A narrowband spectral sensitivity at 800 nm or 500 nm also allows the use of these camera systems without an additional blocking filter here.

Main application areas of the thermal imaging devices described here are:

- Analysis of dynamic thermal processes in product and process development.
- Stationary applications for continuous observation and control of thermal processes.
- Occasional use as a portable measuring device in the maintenance sector and for detecting thermal leaks. A simple to operate Android app allows the use of the compact industrial cameras together with a smart phone.

For use in the R&D sector, the option for video recording with high image frequency has proven advantageous. This allows thermal processes, which are only in the field of view of the camera for a short period, to be analyzed later in the software. This allows individual images to be extracted from this kind of video sequence with full geometric and thermal resolution. In addition exchangeable lenses - including a microscopic lens - allow numerous options to adapt the device to the different measurement tasks: While 6° lenses are more suitable for observing details from a great distance, using a microscopic lens, objects can be measured with a geometric resolution of 28 μm².

Infrared cameras and applications

With stationary installations of USB infrared cameras, their galvanically separated process interface becomes an advantage, where the temperature information generated from the thermal image can be transmitted as 0/4-20 mA or 0-10 V signals. In addition area-related emissivities or non-contact or contact reference temperature measurements can be fed into the camera system through a voltage input. For quality documentation an additional digital input can trigger snapshots of images or video sequences. These kind of individual product related thermal images can also be stored automatically on central servers.



Microscope optics PI 640 for the inspection of PCBs

Analysis software guarantees flexibility

Since USB infrared cameras use standard USB video class or HID drivers integrated within the Windows operating system, no driver installation is required. The single-pixel related temperature calculation takes place in the PC. Compared with visual cameras despite the relatively low geometric resolutions of infrared cameras (e.g. 307,200 pixels with VGA resolution) the image quality is surprisingly good nevertheless. This is achieved using a complex software-based rendering algorithm.

The user software is also extremely flexible. In addition to the standard functions the software includes the following features:

- Numerous options for exporting data and thermal images to support off-line analysis.
- Freely positionable profile representations.
- An unlimited number of measuring fields with separate alarm options.
- Differential video views based on reference images.
- Measurement of moving objects through tiny slots (Line scanning).
- Overlapping multiple images to produce an overall image (Merging).
- riggering of the images according to defined events (Event grabbing).

The software also offers a layout mode, which saves a whole variety of presentation modes and restores them. A video editor allows the processing of the radiometric AVI data (.ravi). These kinds of files can also be analyzed off-line using the software which can be used in multiple ways in parallel. The video recording modes include intermittent modes, which allow slow thermal processes to be captured and viewed at higher speed.

The transfer of data to other programs takes place through a comprehensively documented DLL as part of the Software Development Kit. All other camera functions can also be controlled via the DLL interface. Alternatively, the software can communicate with a serial (com) port, and therefore for example activate an RS422 interface directly. Drivers for Linux are also available.

Industrial accessories allow wide applications

In order to be able to use modern infrared measurement technology in the global industry, suitable accessory equipment is required. As well as the obligatory (high-temperature) cables and interface converters (for example from USB to ethernet) these include in particular protective housings for rugged environments, which allow the cameras to be used at environmental temperatures up to 250° C (482 °F) or 315° C (599 °F).

For outdoor use special heated camera housings are available. This allows the cameras to be used in a wide range of climatic conditions from -40° C (-40°F) up to +50° C (122 °F).

Laminar air purge collars, which prevent condensation and dust deposits on the camera optical systems and protective windows - both can be combined with cooling and protective housings - completing the range of accessories. For extremely harsh atmospheric conditions or where parts may impact the camera, a so-called shutter (servo controlled closing flap) provides reliable protection for the camera optics.



Water cooling with shutter for Xi series



Outdoor protection housing with infrared camera of PI series

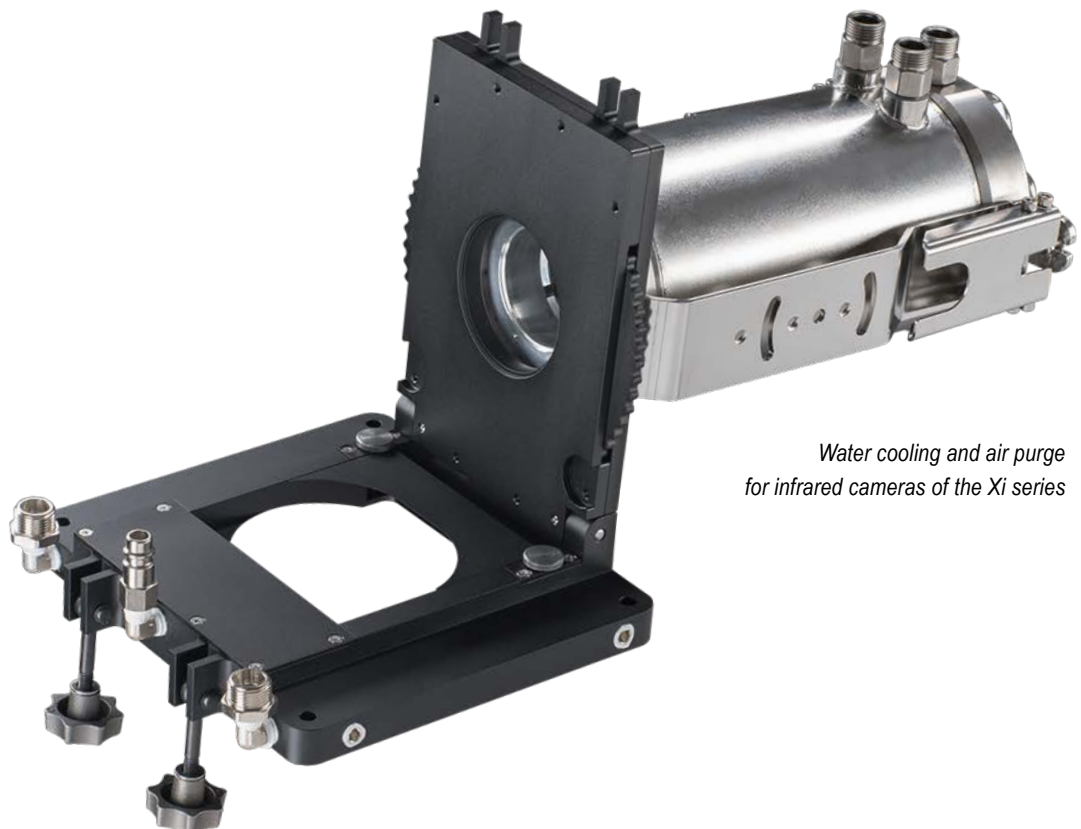

Water cooling and air purge for infrared cameras of the Xi series

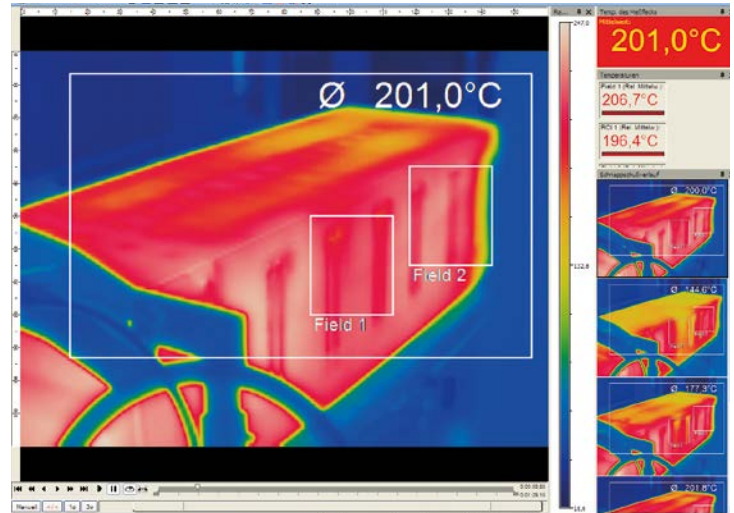

Examples for different options of IR video and image-analysis

Since the time point of the test body running through may vary, a video sequence must be recorded at 120 Hz, in order to measure the temperature profile of a pre-form. Here, the camera is positioned in such a way that it „follows“ the movement of the material from an oblique angle - similar to the last carriage of a moving train. The resulting infrared video sequence shows the temperature profile which is important for adjusting the heating parameters.

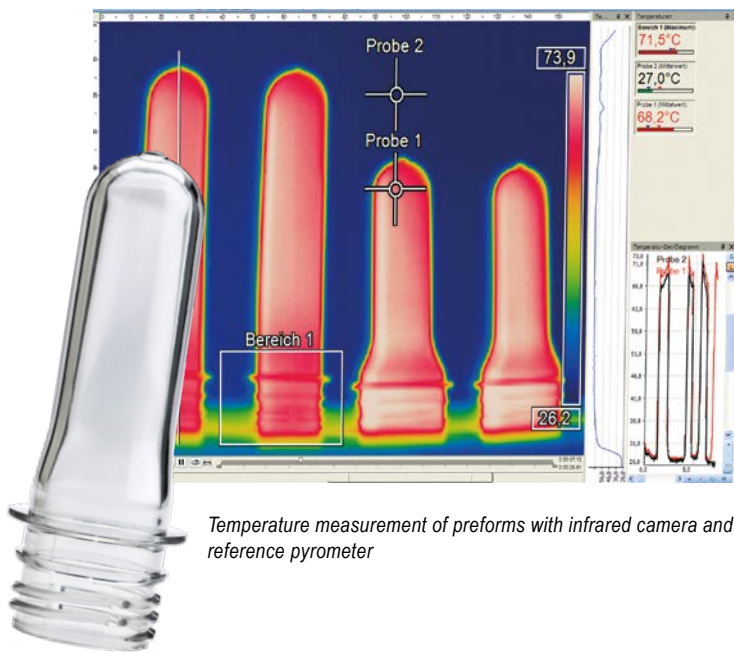

Temperature measurement of preforms with infrared camera and reference pyrometer



Software PIX Connect for the observation of planer machines. Image: binderholz

During vacuum forming for large plastic parts for refrigerators, video recording allows the exact measurement of the cooling behavior at different points of the molded part. Different cooling speeds result in distortion of the material. Delayed deformations occurring in the plastics due to memory effects - for example in dashboards - can be avoided by optimizing the cooling speeds. Similar to using an oscilloscope for analysis of electrical signal profiles, the infrared video camera is an important tool for evaluating dynamic thermal processes.

Applications

A series of five typical applications will be discussed below as examples of the range of applications of USB infrared cameras.

1. Optimization of manufacturing processes

The manufacturing of plastic parts such as PET bottles requires defined heating of the so-called pre-form, in order to guarantee a homogeneous material thickness when blow molding the bottle. During test runs the manufacturing plant is operated with just a few 20 mm thick blanks at full working speed of around one m/s.

2. From fire protection to quality control - infrared cameras monitor planing systems

A whole range of products is machined on modern planing systems. If parts on these types of machines become too hot, in the worst case this could lead to the shavings igniting and resulting in a fire. Infrared cameras detect overheated parts immediately thereby removing the risk of fire effectively. However infrared technology can do more: Scorching caused by excessive contact pressure on the wood is minimized.

When manufacturing rough sawn solid wood parts, today multi-side planing machines are used, where the wood is smoothed, planed and if necessary profiled. One machine has multiple spindles, which machine the workpiece in a continuous run from all sides. During the process, the wood moves at a speed of up to 3.4 meters per second through the planing line. Linear guides and pressure shoes push the wood parts against the spindles. If the pressure is too high, the inlet guides overheat due to excessive friction, which can lead to a fire in the worst case. Drive technology components, such as gearboxes, motors and driveshafts can also overheat.

The monitoring of temperatures on the planing lines also offers the possibility, to evaluate the temperature of the wood surface, which can become extremely warm depending on the contact pressure. The resulting discolorations and scorch marks affect the quality of the end product. Thanks to non-contact temperature monitoring directly in machine, the scrap rate can be reduced.

If damage is detected at an early stage of the machine and on the wood, maintenance team and production teams can replace the corresponding parts or optimize the process, before damage occurs. In this way a breakdown with a longer period of lost production as well as poor quality wooden parts is avoided.

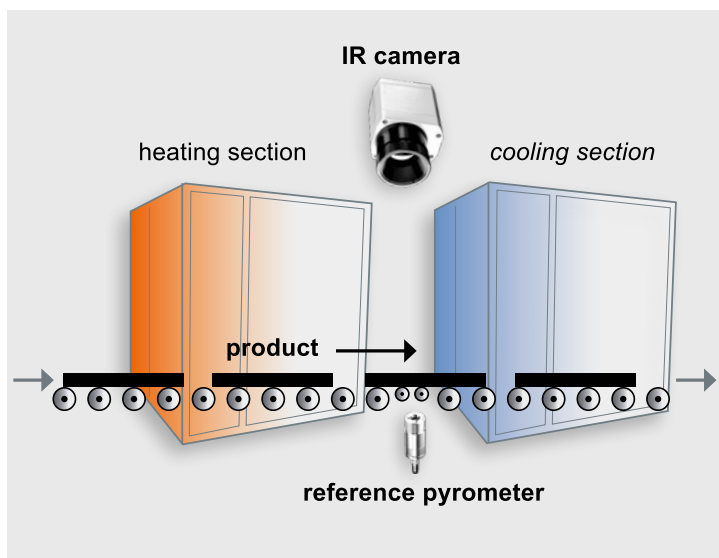

Thermal image measurement on a glass tempering line with IR camera and reference pyrometer.

3. Line camera application in glass hardening plants (Linescan)

Once glass for buildings has been cut into its final form, it often requires surface hardening. This is done in hardening plants, where the cut glass is heated to around 600° C in an oven. After this heating, the material is transported via mobile rollers from the oven into an air cooling section, where the surface is quickly and evenly cooled. This creates the fine crystalline hardened structure which is important for the safety glass. This structure, and therefore the fracture toughness of the glass depends on the most even possible heating of all areas.

Since the oven housing and the cooling section lie close together, it is only possible to observe glass surfaces transported out of the oven through a tiny gap. For this reason the material only appears in a few rows on the thermal image.

The software now allows a special presentation, where the full image of the glass pane is reconstructed line by line as it moves past the gap at a constant velocity.

The camera measures the gap diagonally, so that with a 90° lens a field of view of 111° results. Since glass may have different emissivities depending on the surface coating, an infrared thermometer measures the exact surface temperature on the uncoated underside at the optimum wavelength for glass surfaces of 5 µm. The temperatures recorded along this line from the thermal image are communicated via the analog input of the camera and compared here with the corresponding camera measuring values. The result is a corrected emissivity for the complete measurement image. At the end the measurement images allow exact adjustment of all heating sections in the oven, thereby ensuring good thermal homogeneity.

With coated glass measuring the temperature from below is often the only option. In order to optimally protect the cameras against falling debris, suitable accessories are available, including a shutter mechanism for Compact Line infrared cameras.

4. Temperature measurement on tiny components in electronics development

In the development of electronics a clear trend has been observed in recent years: The devices are becoming significantly more powerful and at the same time the packing density is increasing. As a result during development thermal issues must be dealt with equally carefully. Modern infrared measurement technology is an important aid here.

The greater integration density leads to the fact that the amount of heat which results from the power losses in the components is becoming larger and larger. In addition there is a trend for continuous miniaturization, which can hinder

Infrared cameras and applications

efficient heat removal. The lifetime of semiconductor components however is strongly temperature-dependent, which makes the thermal behavior of boards and assemblies a significant issue.

Infrared measuring technology works quickly, precisely and - especially important for electronics manufacture - without contacting the object. In order to safely record the temperatures even on very small components and structures on a circuit board, an infrared camera with a suitably high resolution is required. This example allows exact detection of which component on a circuit board has excessively high temperatures.



Microscope optics Xi 400 for the analysis of smallest components

Infrared cameras are used in various phases of electronics development: upfront with thermal model calculations, in production and in final inspection as part of quality assurance.

5. Keeping the temperature of the molten mass under control

Pouring metals is one of the most important molding processes in the metal-processing industry. Like in most processes in series production, automated solutions are nowadays being used more frequently in pouring technology as well. For example with ladle casting machines, the infrared temperature measurement technology is used to monitor the temperature of the melt during casting.

Among other things, the quality of the pouring process is heavily dependent on the temperature of the molten mass. Traditionally, it is determined in the induction melting furnace before being filled in the pouring ladle. Despite the quick ladle change and the low temperature loss in the ladle during transport, the temperature is determined again during the pouring process itself using an infrared camera. An unacceptably low temperature in the melt would unquestionably lead to quality problems in the workpiece.

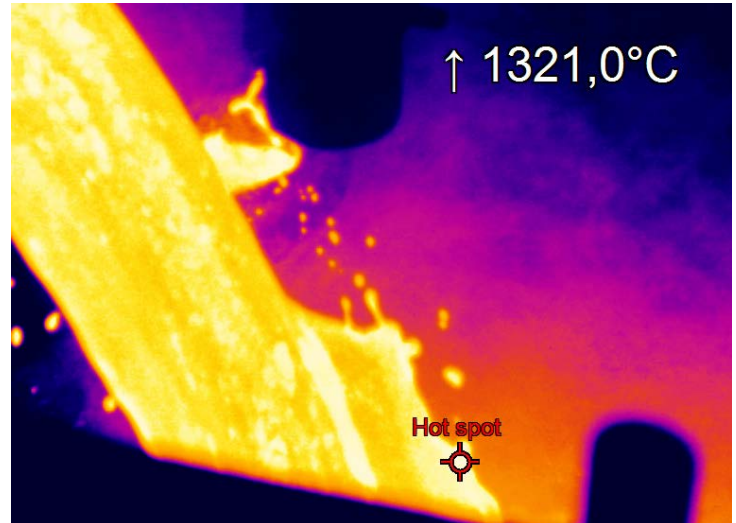

Due to the continuous measuring range from 900 to 2450 °C, the PI 05M is particularly suitable for the temperature measurement of molten metals.

The PI 05M IR camera has an optical resolution of 764 x 480 pixels and allows for an image refresh rate of up to 1 kHz. It also has a very useful function for this application: The highest temperature within the image - the hotspot - can be automatically calculated and retained with a 'peak hold' function. Smoke or vapor arising during the casting also causes no problems for the temperature measurement of the camera.

Summary

The new camera technology is a novelty in the infrared market regarding flexibility and a range of applications. As well as complex temperature analyses, in conjunction with mobile peripherals, the devices are also suitable for taking care of simple maintenance tasks. With the exception of the hardware of the USB infrared camera measuring head itself, both of the other two main components of the thermographic system described, namely Windows software and PC hardware, can always be updated. This allows the overall system to become more powerful over time. On the one hand this is done by simply downloading software updates and extensions. On the other, due to the standardized USB interface, the measuring system can be upgraded at any time with further technological and functional PC hardware developments.

Infrared thermometers and applications

Point detection of surface temperatures is the „mother of infrared measuring technology“. Infrared thermometers or pyrometers can be used in a wide range of sectors due to their different laser technologies and filters. Often it is sufficient, to control a complete process with a point measurement. In this case the price/performance ratio of the thermometer is unbeatable compared with the IR camera.

Stationary infrared thermometers Compact and high-performance series

Stationary infrared thermometers are often used for quality control in manufacturing lines. As well as non-contact temperature measurement and displaying of the measuring data, it is also possible to control the process temperatures.

The wide range of options for adapting pyrometers to the measuring problem allows both uncomplicated retrofitting to existing production systems, as well as future-proof equipping of new plants in close cooperation with OEM customers in the mechanical engineering sector. A wide range of applications can be found:

1. Temperature measurements during induction hardening

Heat treatment in metal processing has taken on an important role these days. Through targeted heat treatment of metals, properties such as corrosion resistance, magnetism, hardness, ductility, wear resistance and fracture behavior can be influenced.

One version of heat treatment is induction hardening. Here a component is placed in a strong alternating field, which causes it to be heated, following which it can be 'frozen' in the desired structure. By controlling the frequency it is possible to adjust the local penetration depth of heat into the material, thereby treating specific areas of the component. The desired material structure of the metal depends on optimum temperature-time profile. For this reason it is necessary to permanently monitor the temperature.

Due to the strong electromagnetic fields, the CT laser 1M, 2M or 3M are particularly suitable, since the electronic equipment is removed from the measuring head and can therefore be well protected against the radiation.



CTlaser

Infrared thermometers and applications

2. Exact temperature control for the manufacture of innovative plastic parts



CT LT - Measuring head with laminar air purge device in a thermoforming machine

Plastics play a major role in many sectors. In particular for challenging application areas such as automotive engineering, new manufacturing techniques and material combinations are constantly being developed. Endless fiber reinforced thermoplastics are a typical example for this. The components are strong, can have complex geometries and despite this have a low weight. At the same time the process is able to have short cycle times, which is particularly important with respect to mass production in large quantities.

They are initially heated and then formed into the desired geometry through a thermoforming process. The decisive factor for the overall process is to have a surface temperature distribution which is as uniform as possible. Traditional temperature controllers are at their limit here. Type CT LT 22 pyrometers are used. Decisive arguments for this IR thermometer were its compactness, the ability to use the device in high environmental temperatures up to 180° C, and the individual adaptation to the application through the industrial accessories - in this case an air purge collar. According to the company the measuring devices have not failed in more than 10 years.

3. Controlling the temperature of paper web and glue application during the production of composite cardboards



Infrared temperature measurement in paper and board production

The high production speeds of the web in modern paper laminating machines require exact and rapid control of the temperature of the paper, of the adhesive and of the base product to be laminated. Only with exact compliance of the temperature conditions determined by the technology between the product components is exact and distortion free lamination achieved.

The temperature monitoring and control of the roller temperature using miniaturized infrared temperature sensors at defined measuring points, transverse to the web movement on the pressure roller and on the glue application roller, allow high uniformity of lamination. Air purge and cleaning devices on the optical channel of the infrared sensors allow maintenance-free measurement operation. Intelligent signal processing of the data from infrared sensors at the edge of the web also allows geometric adjustment of the glue application equipment.



CS sensor head



CSmicro

4. Infrared thermometers control joining process



Infrared temperature measurement in packaging machines

When bonding components of variety - including different types - materials, the curing process is a very important component. It consumes capital, is time intensive and not least is critical with respect to the quality of the joined products. The requirements for corresponding measuring and control systems are becoming more onerous, and are increasingly based on temperature control via infrared measurement technology.

The temperature is one of the most important physical values when bonding. If it is too low, the adhesive becomes brittle. If it is too high, the material may soften or can even melt or degrade. By using different wavelengths of one infrared radiating body, the adhesive can be temperature controlled through the components. Shortwave radiation penetrates deep into solid materials and ensures even heating.

The temperature of the components is determined by non-contact measurement using an infrared thermometer of type CT LT. In conjunction with electronic PID temperature controllers, the infrared radiators cycle and pulse at exact temperatures in the calculated frequencies, thereby imparting the energy with optimum power density into the adhesives without harming the workpiece.

Compliance with the parameters „temperature distribution“ and „energy penetration depth“ guarantees the optimum temperature control.

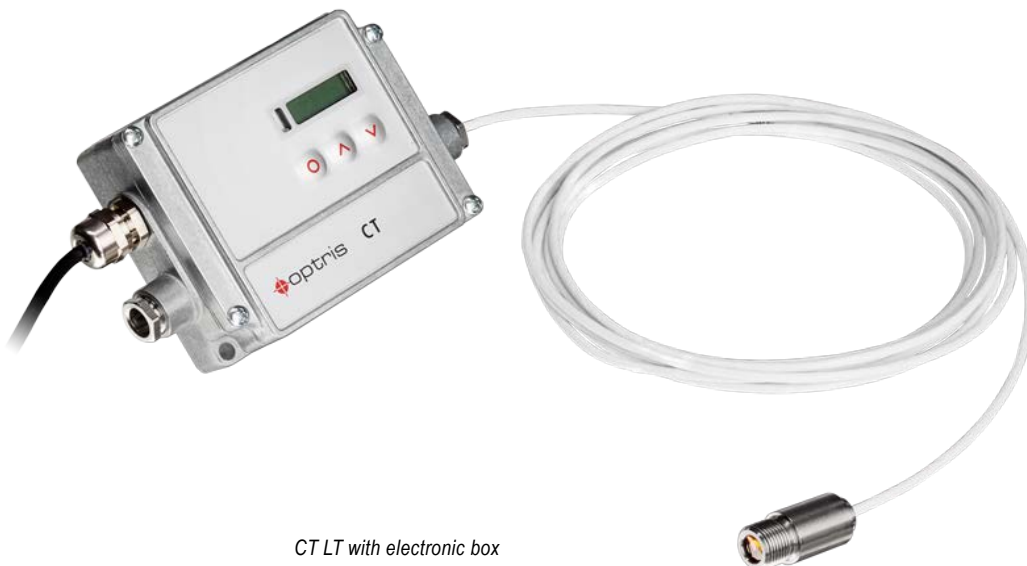

CT LT with electronic box

Portable infrared thermometers



Detailed infrared temperature measurement on a melt in the casting plant with P20 05M.

Portable infrared thermometers (aka laser thermometers) are mainly used for sporadic and localized temperature measurement as part of preventative maintenance. Application areas include the inspection of electrical systems, rotating machinery as well as diagnostic tools in heating, ventilation and air conditioning technology. They are also used for rapid fault analysis in the automotive sector.

Whether used indoors or outdoors, in sunshine, rain or varying temperatures, the devices - in contrast to cheap DIY

Portable thermometers are also available in different spectral ranges. As well as the long-wave area (8 to 14 μm) these particularly include the short-wave areas 525 nm, 1 μm and 1.6 μm . In particular short-wave IR thermometers are used globally in the metal industry. They can measure objects add up to 2000° C with an optical resolution of up to 300:1, which is ideally suited for (molten) metal.

P20 LT

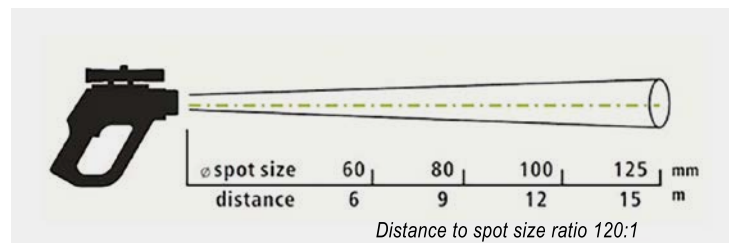

D:S = 120:1



Portable infrared thermometer P20 05M



Below is an excerpt from our online encyclopedia, which can be found at www.optris.com/lexicon

Term	Explanation
Absorption	Ratio of absorbed radiation by an object to incoming radiation. A number between 0 and 1.
Emissivity	Emitted radiation of an object compared to the radiation from a black body source. A number between 0 and 1.
Filter	Material, only permeable by certain infrared wavelengths.
FOV	Field of view: Horizontal field of view of an infrared lens.
FPA	Focal Plane Array: type of an infrared detector.
Gray Body Source	An object, which emits a certain part of the energy which a black body source emits at every wavelength.
IFOV	Instantaneous field of view: A value for the geometric resolution of a thermal imager.
NETD	Noise equivalent temperature difference. A value for the noise (in the image) of a thermal imager.
Object parameter	Values, with which measurement conditions and measuring object are described (e.g. emissivity, ambient temperature, distance, etc.)
Object signal	A non-calibrated value, which refers to the radiation the thermal imager receives from the measuring object.
Palette	Colors of the infrared image
Pixel	Synonym for picture element. A single picture point in an image.
Reference temperature	Temperature value used to compare regular measuring data.
Reflection	Ratio of radiation reflected by the object and incoming radiation. A number between 0 and 1.
Black body source	Object with a reflection of 0. Any radiation is based on its own temperature.
Spectral specific radiation	Energy emitted by an object relevant to time, area and wavelength ($W/m^2/\mu m$).
Specific radiation	Energy emitted from an object relevant to units of time and area (W/m^2).
Radiation	Energy emitted by an object relevant to time, area and solid angle ($W/m^2/sr$).
Radiation flow	Energy emitted by an object relevant to the unit of time (W).
Temperature difference	A value determined by subtraction of one temperature value from another.
Temperature range	Current temperature measuring range of a thermal imager. Imagers can have several temperature ranges. They are described with the help of two black body source values, which serve as threshold values for the current calibration.
Thermogram	Infrared image
Transmissivity	Gases and solid states have different transmissivities. Transmissivity describes the level of infrared radiation, which permeates the object. A number between 0 and 1.
Ambient environment	Objects and gases, which pass radiation to the measuring object.

Appendix: Emissivity table

T: total spectrum SW: 2–5 μm LW: 8–14 μm LLW: 6,5–20 μm					
			References		
Material	Specification	Temp. in °C (°F)	Spectrum	Emissivity	R
Aluminum	Plate, 4 samples differently scratched	70 (158)	LW	0.03–0.06	9
Aluminum	Plate, 4 samples differently scratched	70 (158)	SW	0.05–0.08	9
Aluminum	anodized, light gray, dull	70 (158)	LW	0.97	9
Aluminum	anodized, light gray, dull	70 (158)	SW	0.61	9
Aluminum	anodized, light gray, dull	70 (158)	LW	0.95	9
Aluminum	anodized, light gray, dull	70 (158)	SW	0.67	9
Aluminum	anodized plate	100 (212)	T	0.55	2
Aluminum	film	27 (81)	3 μm	0.09	3
Aluminum	film	27 (81)	10 μm	0.04	3
Aluminum	roughened	27 (81)	3 μm	0.28	3
Aluminum	roughened	27 (81)	10 μm	0.18	3
Aluminum	cast, sandblasted	70 (158)	LW	0.46	9
Aluminum	cast, sandblasted	70 (158)	SW	0.47	9
Aluminum	dipped in HNO ₃ , plate	100 (212)	T	0.05	4
Aluminum	polished	50 ... 100 (122 ... 212)	T	0.04–0.06	1
Aluminum	polished, plate	100 (212)	T	0.05	2
Aluminum	polished, plate	100 (212)	T	0.05	4
Aluminum	roughened surface	20 ... 50 (68 ... 122)	T	0.06–0.07	1
Aluminum	deeply oxidized	50 ... 500 (122 ... 932)	T	0.2–0.3	1
Aluminum	deeply weather beaten	17 (63)	SW	0.83–0.94	5
Aluminum	unchanged, plate	100 (212)	T	0.09	2
Aluminum	unchanged, plate	100 (212)	T	0.09	4
Aluminum	vacuumcoated	20 (68)	T	0.04	2
Aluminum bronze		20 (68)	T	0.6	1
Aluminum-hydroxide	powder		T	0.28	1
Aluminumoxide	activated, powder		T	0.46	1
Aluminumoxide	clean, powder (aluminium oxide)		T	0.16	1
Asbestos	floor tiles	35 (95)	SW	0.94	7
Asbestos	boards	20 (68)	T	0.96	1
Asbestos	tissue		T	0.78	1
Asbestos	paper	40 ... 400 (104 ... 752)	T	0.93–0.95	1
Asbestos	powder		T	0.40–0.60	1
Asbestos	brick	20 (168)	T	0.96	1
Asphalt, road surface		4 (39)	LLW	0.967	8
Brass	treated with 80-sandpaper	20 (68)	T	0.2	2
Brass	plate, milled	20 (68)	T	0.06	1
Brass	plate, treated with sandpaper	20 (68)	T	0.2	1
Brass	strongly polished	100 (212)	T	0.03	2
Brass	oxidized	70 (158)	SW	0.04–0.09	9
Brass	oxidized	70 (158)	LW	0.03–0.07	9
Brass	oxidized	100 (212)	T	0.51	2

Material	Specification	Temp. in °C (°F)	Spectrum	Emissivity	R
Brass	oxidized at 600 °C	200 ... 600 (392 ... 1,112)	T	0.59–0.61	1
Brass	polished	200 (392)	T	0.03	1
Brass	blunt, patchy	20 ... 350 (68 ... 662)	T	0.22	1
Brick	aluminum oxide	17 (63)	SW	0.68	5
Brick	dinas-silicon oxide, fireproof	1,000 (1,832)	T	0.66	1
Brick	dinas-silicon oxide, glazed, toughened	1,100 (2,012)	T	0.85	1
Brick	dinas-silicon oxide, glazed, toughened	1,000 (1,832)	T	0.8	1
Brick	fireproof product, corundom	1,000 (1,832)	T	0.46	1
Brick	fireproof product, magnesit	1,000 ... 1,300 (1,832 ... 2,372)	T	0.38	1
Brick	fireproof product, mildly beaming	500 ... 1,000 (932 ... 1,832)	T	0.76–0.80	1
Brick	fireproof product, strongly beaming	500 ... 1,000 (932 ... 1,832)	T	0.8–0.9	1
Brick	fire brick	17 (63)	SW	0.68	5
Brick	glazed	17 (63)	SW	0.94	5
Brick	brickwork	35 (95)	SW	0.94	7
Brick	brickwork, plastered	20 (68)	T	0.94	1
Brick	normal	17 (63)	SW	0.86–0.81	5
Brick	red, normal	20 (68)	T	0.93	2
Brick	red, raw	20 (68)	T	0.88–0.93	1
Brick	chamotte	20 (68)	T	0.85	1
Brick	chamotte	1,000 (1,832)	T	0.75	1
Brick	chamotte	1,200 (2,192)	T	0.59	1
Brick	amorphus silicon, 95 % SiO ₂	1,230 (2,246)	T	0.66	1
Brick	sillimanite, 33 % SiO ₂ , 64 % Al ₂ O ₃	1,500 (2,732)	T	0.29	1
Brick	waterproof	d17	SW	0.87	5
Bronze	phosphorbronze	70 (158)	LW	0.06	9
Bronze	phosphorbronze	70 (158)	SW	0.08	1
Bronze	polished	50 (122)	T	0.1	1
Bronze	porous, harshened	50 ... 100 (122 ... 212)	T	0.55	1
Bronze	powder		T	0.76–0.80	1
Carbon	Grafit, surface filed	20 (68)	T	0.98	2
Carbon	plumbago powder		T	0.97	1
Carbon	charcoal powder		T	0.96	1
Carbon	candle soot	20 (68)	T	0.95	2
Carbon	lamp soot	20 ... 400 (68 ... 752)	T	0.95–0.97	1
Cast Iron	treated	800 ... 1,000 (1,472 ... 1,832)	T	0.60–0.70	1
Cast Iron	fluent	1,300 (2,372)	T	0.28	1
Cast Iron	cast	50 (122)	T	0.81	1
Cast Iron	blocks made of cast iron	1,000 (1,832)	T	0.95	1
Cast Iron	oxidized	38 (100)	T	0.63	4
Cast Iron	oxidized	100 (212)	T	0.64	2
Cast Iron	oxidized	260 (500)	T	0.66	4
Cast Iron	oxidized	538 (1,081)	T	0.76	4
Cast Iron	oxidized at 600 °C	200 ... 600 (392 ... 1,112)	T	0.64–0.78	1
Cast Iron	polished	38 (100)	T	0.21	4
Cast Iron	polished	40 (104)	T	0.21	2

Material	Specification	Temp. in °C (°F)	Spectrum	Emissivity	R
Cast Iron	polished	200 (392)	T	0.21	1
Cast Iron	untreated	900 ... 1,100 (1,652 ... 2,012)	T	0.87–0.95	1
Chipboard	untreated	20 (68)	SW	0.9	6
Chrome	polished	50 (122)	T	0.1	1
Chrome	polished	500–1,000 (932 ... 1,832)	T	0.28–0.38	1
Clay	burnt	70 (158)	T	0.91	1
Cloth	black	20 (68)	T	0.98	1
Concrete		20 (68)	T	0.92	2
Concrete	pavement	5 (41)	LLW	0.974	8
Concrete	roughened	17 (63)	SW	0.97	5
Concrete	dry	36 (97)	SW	0.95	7
Copper	electrolytic, brightly polished	80 (176)	T	0.018	1
Copper	electrolytic, polished	–34 (–29)	T	0.006	4
Copper	scraped	27 (81)	T	0.07	4
Copper	molten	1,100 ... 1,300 (2,021 ... 2,372)	T	0.13–0.15	1
Copper	commercial, shiny	20 (68)	T	0.07	1
Copper	oxidized	50 (122)	T	0.6–0.7	1
Copper	oxidized, dark	27 (81)	T	0.78	4
Copper	oxidized, deeply	20 (68)	T	0.78	2
Copper	oxidized, black		T	0.88	1
Copper	polished	50 ... 100 (122 ... 212)	T	0.02	1
Copper	polished	100 (212)	T	0.03	2
Copper	polished, commercial	27 (81)	T	0.03	4
Copper	polished, mechanical	22 (72)	T	0.015	4
Copper	clean, thoroughly prepared surface	22 (72)	T	0.008	4
Copperoxide	powder		T	0.84	1
Copperoxide	red, powder		T	0.7	1
Earth	saturated with water	20 (68)	T	0.95	2
Earth	dry	20 (68)	T	0.92	2
Enamel		20 (68)	T	0.9	1
Enamel	paint	20 (68)	T	0.85–0.95	1
Fiberboard	hard, untreated	20 (68)	SW	0.85	6
Fiberboard	Ottrelith	70 (158)	LW	0.88	9
Fiberboard	Ottrelith	70 (158)	SW	0.75	9
Fiberboard	particle plate	70 (158)	LW	0.89	9
Fiberboard	particle plate	70 (158)	SW	0.77	9
Fiberboard	porous, untreated	20 (68)	SW	0.85	6
Glass	thin	25 (77)	LW	0.8–0.95	10
Glazing Rebates	8 different colors and qualities	70 (158)	LW	0.92–0.94	9
Glazing Rebates	9 different colors and qualities	70 (158)	SW	0.88–0.96	9
Glazing Rebates	aluminum, different age	50 ... 100 (122 ... 212)	T	0.27–0.67	1
Glazing Rebates	on oily basis, average of 16 colors	100 (212)	T	0.94	2
Glazing Rebates	chrome green		T	0.65–0.70	1
Glazing Rebates	cadmium yellow		T	0.28–0.33	1
Glazing Rebates	cobalt blue		T	0.7–0.8	1
Glazing Rebates	plastics, black	20 (68)	S/W	0.95	6

Material	Specification	Temp. in °C (°F)	Spectrum	Emissivity	R
Glazing Rebates	plastics, white	20 (68)	SW	0.84	6
Glazing Rebates	oil	17 (63)	SW	0.87	5
Glazing Rebates	oil, different colors	100 (212)	T	0.92–0.96	1
Glazing Rebates	oil, shiny gray	20 (68)	SW	0.96	6
Glazing Rebates	oil, gray, dull	20 (68)	SW	0.97	6
Glazing Rebates	oil, black, dull	20 (68)	SW	0.94	6
Glazing Rebates	oil, black, shiny	20 (68)	SW	0.92	6
Gold	brightly polished	200 ... 600 (392 ... 1,112)	T	0.02–0.03	1
Gold	strongly polished	100 (212)	T	0.02	2
Gold	polished	130 (266)	T	0.018	1
Granite	polished	20 (68)	LLW	0.849	8
Granite	roughened	21 (70)	LLW	0.879	8
Granite	roughened, 4 different samples	70 (158)	LW	0.77–0.87	9
Granite	roughened, 4 different samples	70 (158)	SW	0.95–0.97	9
Gypsum		20 (68)	T	0.8–0.9	1
Gypsum, applied		17 (63)	SW	0.86	5
Gypsum, applied	gypsum plate, untreated	20 (68)	SW	0.9	6
Gypsum, applied	roughened surface	20 (68)	T	0.91	2
Iron and Steel	electrolytic	22 (72)	T	0.05	4
Iron and Steel	electrolytic	100 (212)	T	0.05	4
Iron and Steel	electrolytic	260 (500)	T	0.07	4
Iron and Steel	electrolytic, brightly polished	175 ... 225 (347 ... 437)	T	0.05–0.06	1
Iron and Steel	freshly milled	20 (68)	T	0.24	1
Iron and Steel	freshly processed with sandpaper	20 (68)	T	0.24	1
Iron and Steel	smoothed plate	950 ... 1,100 (1,742 ... 2,012)	T	0.55–0.61	1
Iron and Steel	forged, brightly polished	40–250 (104 ... 482)	T	0.28	1
Iron and Steel	milled plate	50 (122)	T	0.56	1
Iron and Steel	shiny, etched	150 (302)	T	0.16	1
Iron and Steel	shiny oxide layer, plate	20 (68)	T	0.82	1
Iron and Steel	hot milled	20 (68)	T	0.77	1
Iron and Steel	hot milled	130 (266)	T	0.6	1
Iron and Steel	cold milled	70 (158)	LW	0.09	9
Iron and Steel	cold milled	70 (158)	SW	0.2	9
Iron and Steel	covered with red dust	20 (68)	T	0.61–0.85	1
Iron and Steel	oxidized	100 (212)	T	0.74	1
Iron and Steel	oxidized	100 (212)	T	0.74	4
Iron and Steel	oxidized	125–525	T	0.78–0.82	1
Iron and Steel	oxidized	200 (392)	T	0.79	2
Iron and Steel	oxidized	200 ... 600 (392 ... 1,112)	T	0.8	1
Iron and Steel	oxidized	1,227 (2,240)	T	0.89	4
Iron and Steel	polished	100 (212)	T	0.07	2
Iron and Steel	polished	400–1,000 (752 ... 1,832)	T	0.14–0.38	1

Appendix: Emissivity table

Material	Specification	Temp. in °C (°F)	Spectrum	Emissivity	R
Iron and Steel	polished plate	750 ... 1,050 (1,382 ... 1,922)	T	0.52–0.56	1
Iron and Steel	harshened, even surface	50 (122)	T	0.95–0.98	1
Iron and Steel	rusty, red	20 (68)	T	0.69	1
Iron and Steel	rusty, red, plate	22 (72)	T	0.69	4
Iron and Steel	deeply oxidized	50 (122)	T	0.88	1
Iron and Steel	deeply oxidized	500 (932)	T	0.98	1
Iron and Steel	deeply rusted	17 (63)	SW	0.96	5
Iron and Steel	deeply rusted plate	20 (68)	T	0.69	2
Iron tinned	plate	24 (75)	T	0.064	4
Ice:	see water				
Iron, galvanized	plate	92 (198)	T	0.07	4
Iron, galvanized	plate, oxidized	20 (68)	T	0.28	1
Iron, galvanized	plate, oxidized	30 (86)	T	0.23	1
Iron, galvanized	deeply oxidized	70 (158)	LW	0.85	9
Iron, galvanized	deeply oxidized	70 (158)	SW	0.64	9
Lead	shiny	250 (482)	T	0.08	1
Lead	non oxidized, polished	100 (212)	T	0.05	4
Lead	oxidized, gray	20 (68)	T	0.28	1
Lead	oxidized, gray	22 (72)	T	0.28	4
Lead	oxidized at 200 °C	200 (392)	T	0.63	1
Lead, red		100 (212)	T	0.93	4
Lead, red, powder		100 (212)	T	0.93	1
Leather	tanned fur		T	0.75–0.80	1
Limestone			T	0.3–0.4	1
Magnesium		22 (72)	T	0.07	4
Magnesium		260 (500)	T	0.13	4
Magnesium		538 (1,081)	T	0.18	4
Magnesium	polished	20 (68)	T	0.07	2
Magnesium-powder			T	0.86	1
Molybdenum		600 ... 1,000 (1,112 ... 1,832)	T	0.08–0.13	1
Molybdenum		1,500 ... 2,200 (2,732 ... 3,992)	T	0.19–0.26	1
Molybdenum	twine	700 ... 2,500 (1,292 ... 4,532)	T	0.1–0.3	1
Mortar		17 (63)	SW	0.87	5
Mortar	dry	36 (97)	SW	0.94	7
Nickel	wire	200 ... 1,000 (392 ... 1,832)	T	0.1–0.2	1
Nickel	electrolytic	22 (72)	T	0.04	4
Nickel	electrolytic	38 (100)	T	0.06	4
Nickel	electrolytic	260 (500)	T	0.07	4
Nickel	electrolytic	538 (1,081)	T	0.1	4
Nickel	galvanized, polished	20 (68)	T	0.05	2
Nickel	galvanized on iron, not polished	20 (68)	T	0.11-0.40	1
Nickel	galvanized on iron, not polished	22 (72)	T	0.11	4
Nickel	galvanized on iron, not polished	22 (72)	T	0.045	4
Nickel	light dull	122 (252)	T	0.041	4

Material	Specification	Temp. in °C (°F)	Spectrum	Emissivity	R
Nickel	oxidized	200 (392)	T	0.37	2
Nickel	oxidized	227 (441)	T	0.37	4
Nickel	oxidized	1,227 (2,241)	T	0.85	4
Nickel	oxidized at 600 °C	200 ... 600 (392 ... 1,112)	T	0.37–0.48	1
Nickel	polished	122 (252)	T	0.045	4
Nickel	clean, polished	100 (212)	T	0.045	1
Nickel	clean, polished	200 ... 400 (392 ... 752)	T	0.07–0.09	1
Nickel-chrome	wire, bare	50 (122)	T	0.65	1
Nickel-chrome	wire, bare	500 ... 1,000 (932 ... 1,832)	T	0.71–0.79	1
Nickel-chrome	wire, oxidized	50 ... 500 (932 ... 932)	T	0.95–0.98	1
Nickel-chrome	milled	700 (1,292)	T	0.25	1
Nickel-chrome	sandblasted	700 (1,292)	T	0.7	1
Nickel-oxide		500 ... 650 (932 ... 1,202)	T	0.52–0.59	1
Nickel-oxide		1,000 ... 1250 (1,832 ... 2,282)	T	0.75–0.86	1
Oil, Lubricating Oil	0.025-mm-layer	20 (68)	T	0.27	2
Oil, Lubricating Oil	0.050-mm-layer	20 (68)	T	0.46	2
Oil, Lubricating Oil	0.125-mm-layer	20 (68)	T	0.72	2
Oil, Lubricating Oil	thick layer	20 (68)	T	0.82	2
Oil, Lubricating Oil	layer on Ni-basis, only Ni-basis	20 (68)	T	0.05	2
Paint	3 colors, sprayed on aluminum	70 (158)	LW	0.92–0.94	9
Paint	4 colors, sprayed on aluminum	70 (158)	SW	0.50–0.53	9
Paint	aluminium on harshened surface	20 (68)	T	0.4	1
Paint	bakelite	80 (176)	T	0.83	1
Paint	heat-proof	100 (212)	T	0.92	1
Paint	black, shiny, sprayed on iron	20 (68)	T	0.87	1
Paint	black, dull	100 (212)	T	0.97	2
Paint	black, dull	40 ... 100 (104 ... 212)	T	0.96–0.98	1
Paint	white	40 ... 100 (104 ... 212)	T	0.8–0.95	1
Paint	white	100 (212)	T	0.92	2
Paper	4 different colors	70 (158)	LW	0.92–0.94	9
Paper	4 different colors	70 (158)	SW	0.68–0.74	9
Paper	coated with black paint		T	0.93	1
Paper	dark blue		T	0.84	1
Paper	yellow		T	0.72	1
Paper	green		T	0.85	1
Paper	red		T	0.76	1
Paper	black		T	0.9	1
Paper	black, blunt		T	0.94	1
Paper	black, blunt	70 (158)	LW	0.89	9
Paper	black, blunt	70 (158)	SW	0.86	9
Paper	white	20 (68)	T	0.7–0.9	1
Paper	white, 3 different shiny coatings	70 (158)	LW	0.88–0.90	9

Material	Specification	Temp. in °C (°F)	Spectrum	Emissivity	R
Paper	white, 3 different shiny coatings	70 (158)	SW	0.76–0.78	9
Paper	white, bonded	20 (68)	T	0.93	2
Plastics	fiber optics laminate (printed circuit board)	70 (158)	LW	0.91	9
Plastics	fiber optics laminate (printed circuit board)	70 (158)	SW	0.94	9
Plastics	polyurethane-insulating plate	70 (158)	LW	0.55	9
Plastics	polyurethane-insulating plate	70 (158)	SW	0.29	9
Plastics	PVC, plastic floor, blunt, structured	70 (158)	LW	0.93	9
Plastics	PVC, plastic floor, blunt, structured	70 (158)	SW	0.94	9
Platinum		17 (63)	T	0.016	4
Platinum		22 (72)	T	0.05	4
Platinum		260 (500)	T	0.06	4
Platinum		538 (1,081)	T	0.1	4
Platinum		1,000 ... 1,500 (1,832 ... 2,732)	T	0.14–0.18	1
Platinum		1,094 (2,001)	T	0.18	4
Platinum	band	900 ... 1,100 (1,652 ... 2,012)	T	0.12–0.17	1
Platinum	wire	50 ... 200 (122 ... 392)	T	0.06–0.07	1
Platinum	wire	500 ... 1,000 (1,832 ... 1,832)	T	0.10–0.16	1
Platinum	wire	1,400 (2,552)	T	0.18	1
Platinum	clean, polished	200 ... 600 (392 ... 1,112)	T	0.05–0.10	1
Polystyrene	heat insulation	37 (99)	SW	0.6	7
Porcelain	glazed	20 (68)	T	0.92	1
Porcelain	white, glowing		T	0.70–0.75	1
Rubber	hard	20 (68)	T	0.95	1
Rubber	soft, gray, harshened	20 (68)	T	0.95	1
Sand			T	0.6	1
Sand		20 (68)	T	0.9	2
Sandpaper	coarse	80 (176)	T	0.85	1
Sandstone	polished	19 (66)	LLW	0.909	8
Sandstone	harshened	19 (66)	LLW	0.935	8
Silver	polished	100 (212)	T	0.03	2
Silver	clean, polished	200 ... 600 (392 ... 1,112)	T	0.02–0.03	1
Skin	Human Being	32 (90)	T	0.98	2
Slag	basin	0 ... 100 (32 ... 212)	T	0.97–0.93	1
Slag	basin	200 ... 500 (392 ... 932)	T	0.89–0.78	1
Slag	basin	600 ... 1,200 (1,112 ... 2,192)	T	0.76–0.70	1
Slag	basin	1,400 ... 1,800 (2,552 ... 3,272)	T	0.69–0.67	1
Snow:	see water				
Stainless steel	plate, polished	70 (158)	LW	0.14	9
Stainless steel	plate, polished		SW	0.18	9
Stainless steel	plate, not treated, scratched	70 (158)	LW	0.28	9
Stainless steel	plate, not treated, scratched	70 (158)	SW	0.3	9
Stainless steel	milled	700 (1,292)	T	0.45	1
Stainless steel	alloy, 8 % Ni, 18 % Cr	500 (932)	T	0.35	1
Stainless steel	sandblasted	700 (1,292)	T	0.7	1

Material	Specification	Temp. in °C (°F)	Spectrum	Emissivity	R
Stainless steel	type 18–8, shiny	20 (68)	T	0.16	2
Stainless steel	type 18–8, oxidized at 800 °C	60 (140)	T	0.85	2
Stucco	roughened, yellow green	90 (194)	T	0.91	1
Tar			T	0.79–0.84	1
Tar	paper	20 (68)	T	0.91–0.93	1
Tin	shiny	20 ... 50 (68 ... 122)	T	0.04–0.06	1
Tin	tin plate	100 (212)	T	0.07	2
Titanium	oxidized at 540 °C	200 (392)	T	0.4	1
Titanium	oxidized at 540 °C	500 (932)	T	0.5	1
Titanium	oxidized at 540 °C	1,000 (1,832)	T	0.6	1
Titanium	polished	200 (392)	T	0.15	1
Titanium	polished	500 (932)	T	0.2	1
Titanium	polished	1,000 (1,832)	T	0.36	1
Tungsten		200 (392)	T	0.05	1
Tungsten		600 ... 1,000 (1,112 ... 1,832)	T	0.1–0.16	1
Tungsten		1,500 ... 2,200 (2,732 ... 3,992)	T	0.24–0.31	1
Tungsten	twine	3,300 (5,972)	T	0.39	1
Varnish	on parquet flooring made of oak	70 (158)	LW	0.90–0.93	9
Varnish	on parquet flooring made of oak	70 (158)	SW	0.9	9
Varnish	dull	20 (68)	SW	0.93	6
Vulcanite			T	0.89	1
Wall Paper	slightly patterned, light gray	20 (68)	SW	0.85	6
Wall Paper	slightly patterned, red	20 (68)	SW	0.9	6
Water	distilled	20 (68)	T	0.96	2
Water	ice, strongly covered with frost	0 (32)	T	0.98	1
Water	ice, slippery	–10 (14)	T	0.96	2
Water	ice, slippery	0 (32)	T	0.97	1
Water	frost crystals	–10 (14)	T	0.98	2
Water	coated >0.1 mm thick	0 ... 100 (32 ... 212)	T	0.95–0.98	1
Water	snow		T	0.8	1
Water	snow	–10 (14)	T	0.85	2
Wood		17 (63)	SW	0.98	5
Wood		19 (66)	LLW	0.962	8
Wood	planed	20 (68)	T	0.8–0.9	1
Wood	planed oak	20 (68)	T	0.9	2
Wood	planed oak	70 (158)	LW	0.88	9
Wood	planed oak	70 (158)	SW	0.77	9
Wood	treated with sandpaper		T	0.5–0.7	1
Wood	pine, 4 different samples	70 (158)	LW	0.81–0.89	9
Wood	pine, 4 different samples	70 (158)	SW	0.67–0.75	9
Wood	plywood, even, dry	36 (97)	SW	0.82	7
Wood	plywood, untreated	20 (68)	SW	0.83	6
Wood	white, damp	20 (68)	T	0.7–0.8	1
Zinc	plate	50 (122)	T	0.2	1
Zinc	oxidized at 400 °C	400 (752)	T	0.11	1
Zinc	oxidized surface	1,000–1,200 (1,832 ... 2,192)	T	0.50–0.60	1
Zinc	polished	200 ... 300 (392 ... 572)	T	0.04–0.05	1

Appendix: Selection criteria for IR temperature measurement devices

Selection criteria for infrared thermometers

A wide selection of infrared sensors is available for non-contact temperature measurement. The following criteria will help to find the optimal measuring device for your application:

- Initial question
- Temperature range
- Environmental conditions
- Spot size
- Material and surface of the measuring object
- Response time of infrared thermometers
- Interface
- Emissivity

Initial question

The basic question is: point measurement or surface measurement? Based on the aim of application, the use of either an infrared thermometer or an infrared camera is possible. Once this is established, the product must be specified. In exceptional cases, there are also applications where both technologies would make sense; in this situation, we recommend consulting the relevant application engineers.

Temperature range

Choose the temperature range of the sensor as optimal as possible in order to reach a high resolution of the object temperature. The measuring ranges for IR-cameras can be adjusted to the measuring task manually or via digital interface.

Environmental conditions

The maximum acceptable ambient temperature of the sensors is very important. The CT line operates in up to 250 °C (482 °F) without any cooling. By using water and air cooling the measuring devices operate in even higher ambient temperatures. Air purge systems help keep the lenses clean from additional dust in the atmosphere.

Spot size

The size of the measuring object has to be equal to or bigger than the viewing field of the sensor in order to reach accurate results. The spot diameter (S) changes accordingly to the distance of the sensor (D). The brochures specify the D:S relation for the different optics.

Further information is available on the online spot size calculator:
www.optris.com/spot-size-calculator

Material and surface of the measuring object

The emissivity depends on material, surface and other factors. The common rule reads as follows: The higher the emissivity, the easier the measurement generates a precise result. Many infrared sensors offer adjustment of the emissivity. The appropriate values can be taken from the tables in the appendix.

Response time of infrared thermometers

The response time of infrared sensors is very fast as compared to contact thermometers. They range between 1 ms to 250 ms, strongly depending on the detector of the device. Due to the detector, response time is limited in the lower range. The electronics help to correct and adjust the response time according to the application (e.g. average or maximum hold).

Signal output interfaces

The interface supports the analysis of the measuring results. The following interfaces are available:

- Output/ alarm: 0/4 – 20 mA
- Output/ analog: 0 – 10 V
- Thermocouple: Type J, Type K
- Interfaces: CAN, Profibus-DP, RS232, RS485, USB, Relais, Ethernet



You can find an overview of the technical data of all Optris products in our product brochure:

www.optris.com/optris-downloads

Literature

References

- [1] VDI/VDE Richtlinie, Technische Temperaturmessungen – Spezifikation von Strahlungsthermometern, Juni 2001, VDI 3511 Blatt 4.1
- [2] VDI/ VDE Richtlinie Technische Temperaturmessungen, Strahlungsthermometrie – Kalibrierung von Strahlungsthermometern, 2004, VDI/ VDE 3511, Blatt 4.3
- [3] Trouilleau, C. et al.: High-performance uncooled amorphous silicon TEC less XGA IRFPA with 17 μm pixel-pitch; “Infrared technologies and applications XXXV”, Proc. SPIE 7298, 2009
- [4] Schmidgall, T.; Glänzend gelöst – Fehlerdetektion an spiegelnden Oberflächen mit USB2.0 – Industriekameras, A&D Kompendium 2007/2008, S. 219
- [5] Icron Technology Corp.; Options for Extending USB, White Paper, Burnaby; Canada, 2009

Recommended literature

1. VDI/VDE Richtlinie, Technische Temperaturmessungen – Spezifikation von Strahlungsthermometern, Juni 2001, VDI 3511 Blatt 4.1
2. Stahl, Miosga: Grundlagen Infrarottechnik, 1980, Dr. Alfred Hütthig Verlag Heidelberg
3. Walther, Herrmann: Wissensspeicher Infrarotmesstechnik, 1990, Fachbuchverlag Leipzig
4. Walther, L., Gerber, D.: Infrarotmesstechnik, 1983, Verlag Technik Berlin
5. De Witt, Nutter: Theory and Practice of Radiation Thermometry, 1988, John Wiley & Son, New York, ISBN 0-471-61018-6
6. Wolfe, Zissis: The Infrared Handbook, 1978, Office of Naval Research, Department of the Navy, Washington DC.
7. Crastes, A. et al.: Uncooled amorphous silicon $\frac{1}{4}$ VGA IRFPA with 25 μm pixel-pitch for High End applications, “Infrared technologies and applications XXXIV”, Proc. SPIE 6940, 2008
8. Holst, Gerald C.: Electro-optical Imaging System Performance, JCD Publishing Winter Park, Florida USA, 2006, ISBN: 0-8194-6179-2
9. Ulrich Kienitz: Thermal imaging as a modern form of pyrometry, in: Journal of Sensors and Sensor Systems, 3, 265–271, 2014.

innovative infrared technology

Optris Infrared Sensing, LLC
200 International Drive
Suite 170
Portsmouth, NH 03801 USA
Phone: (603) 766-6060
E-mail: sales@optris-ir.com
www.optris.com

